

MAKING A LIVING IN RADIO



JANUARY, 25¢

# RADIO NEWS

## SHORT WAVE RADIO

# IDENTIFYING SHORT WAVE STATIONS

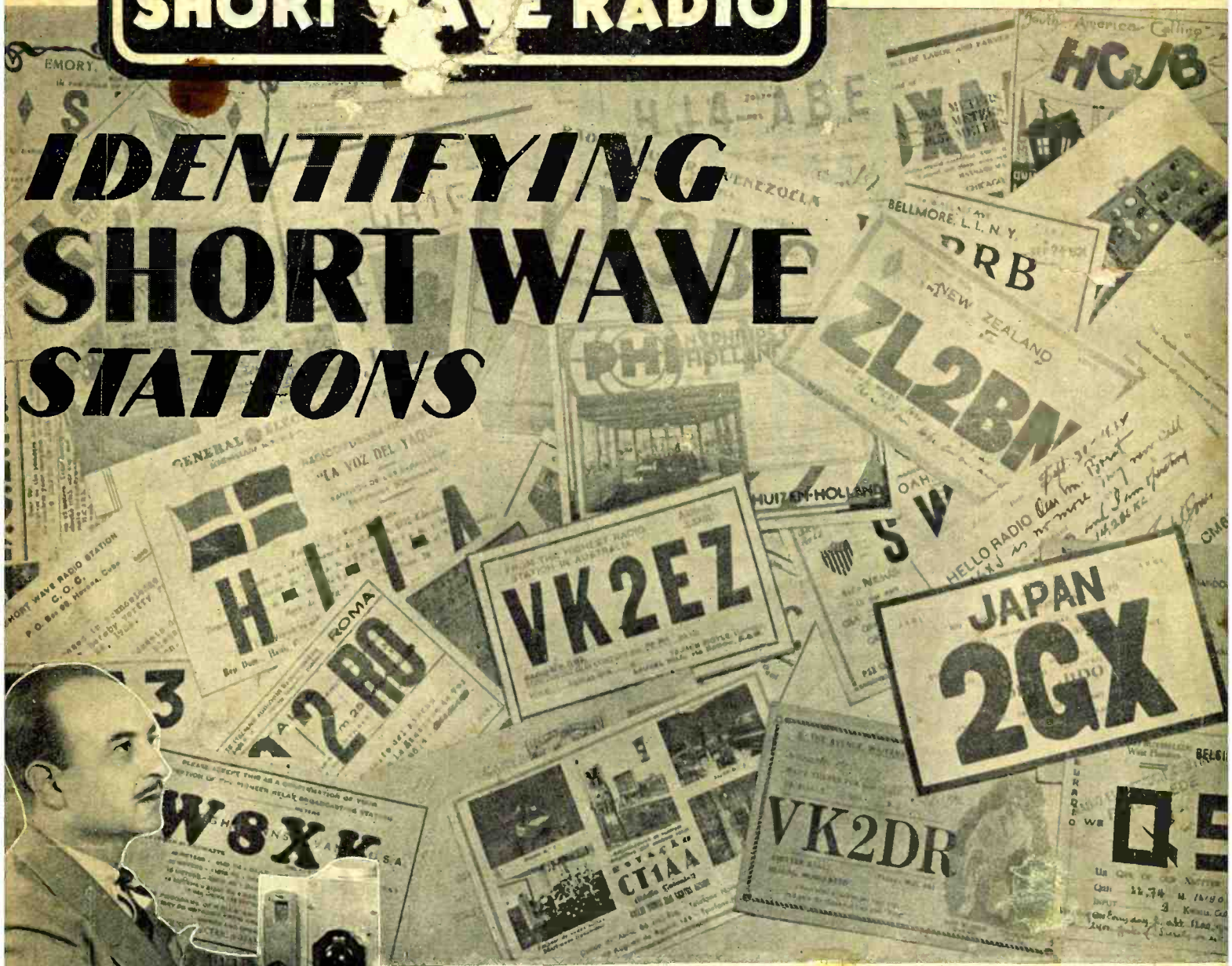

## TELEVISION'S FUTURE

A Publication Devoted to Progress in Radio

Television  
Experiments  
Engineering  
Measurements

Short Waves  
DX Reception  
Broadcasting  
Amateur Activity

Service Work  
Electronics  
Set Building  
Operating Data

# A PERFECT Christmas Gift FOR

# THE LISTENING POST AND THE HOME!

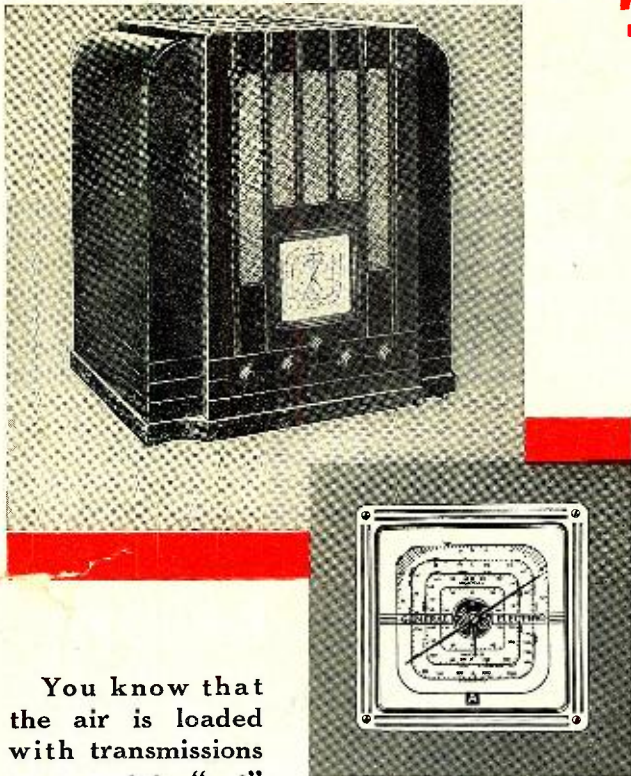

You know that the air is loaded with transmissions you want to "get" — short-wave programs from far and near, amateurs, aircraft, police, Coast Guard — as well as the standard broadcasts. You know, too, that it takes a mighty good receiver to bring them all in clearly, with good volume, little noise, and true fidelity. And a better-than-ordinary dial to bring them *back* again, once you have tuned to other frequencies.

This new General Electric All-wave Radio does it all, with ease! The four-band dial covers the entire sound transmission range from 140 to 18,000 kilocycles. There is plenty of volume for weak signals. The set is adapted to the use of the double-doublet all-wave antenna, taking care of the noise question. The high standard of fidelity for which General Electric Radio has always been noted is readily apparent. The band-spread dial needle, providing minute logging of the fine tuning obtained with a 50 to 1

ratio, gives you micro-accurate return to any short-wave dialing, time after time.

Model M-81, illustrated here, is priced at \$97.50 complete. In addition, there is a full line of other General Electric All-wave models from \$44.95 to \$375.00. (Prices slightly higher West, Mid-West and South.) Prices are subject to change without notice.

Dial divided into four frequency bands covering 140-410, 540-1720, 1720-5400 and 5400-18,000 kilocycles. Practically every service included, with the range conveniently divided into these four bands ★ Band indicator shows visually which band is in use ★ Double-end tuning needle ★ Illuminated dial gives excellent visibility ★ Two tuning ratios, 50 to 1 and 10 to 1, either instantly available ★ Additional needle with separate scale for band-spread tuning. Geared to main needle, nine revolutions to each frequency band. Locates desired frequency easily and quickly. Makes possible accurate logging for future re-dialing ★ Set is adapted for use of double-doublet all-wave antenna, with provision for easy attachment ★ High-gain, 6-watt audio system feeds large built-in dynamic speaker. Plenty of volume for weak signals — excellent fidelity for broadcast reception ★ Set can be adapted for C.W. reception without any changes in chassis wiring. Mail the coupon for details on I.F. oscillator.

GENERAL ELECTRIC COMPANY  
Radio Sales Section, R-881, Bridgeport, Conn.

Please send me full information on adapting M-81 G-E Radio to C.W.

Name.....

Street Address.....

City.....State.....

# GENERAL ELECTRIC

## ALL-WAVE RADIO

MERCHANDISE DEPARTMENT, GENERAL ELECTRIC COMPANY, BRIDGEPORT, CONNECTICUT

# SEND MY FIRST LESSON FREE

*It shows how EASY it is to learn at home to fill a*

# GOOD JOB IN RADIO



*Here's Proof*

Clip the coupon and mail it. I'm so sure that I can train you at home in your spare time for a good job in Radio that I'll send you my first lesson free. Examine it, read it, see how clear and easy it is to understand. Then you will know why many men with less than a grammar school education and no technical experience have become Radio Experts and are earning two to three times their former pay as a result of my training.

**Many Radio Experts Make \$40, \$60, \$75 A Week**

In less than 15 years, the Radio Industry has grown from a few million to hundreds of millions of dollars. Over 300,000 jobs have been created by this growth, and thousands more will be created by its continued development. Many men and young men with the right training—the kind of training I give you in the N. R. I. course—have stepped into Radio at two and three times their former salaries.

### Get Ready Now for Jobs Like These

Broadcasting stations use engineers, operators, station managers and pay up to \$5,000 a year. Manufacturers, continually employ testers, inspectors, foremen, engineers, servicemen, buyers, for jobs paying up to \$7,500 a year. Radio operators on ships enjoy life, see the world, with board and lodging free, and get good pay besides. Dealers and jobbers employ servicemen, salesmen, buyers, managers, and pay up to \$100 a week. My book tells you about these and many other interesting Radio jobs.

### Many Make \$5, \$10, \$15 A Week Extra In Spare Time While Learning

The day you enroll with me, I send you instructions which you should master quickly for doing 28 Radio jobs common in most every neighborhood, for spare time money. Throughout your training, I send you information for servicing popular makes of sets! I give you the plans and ideas that have made \$200 to \$1,000 a year for N. R. I. men in their spare time. My Course is famous as the Course that pays for itself!

### Television, Short Wave, Loud Speaker Systems Included

There's opportunity for you in Radio. Its future is certain. Television, short wave, loud speaker systems, police Radio, automobile Radio, aircraft Radio—in every branch, developments and improvements are taking place. Here is a real future for thousands and thousands of men who really know Radio—men with N. R. I. training. Get the training that opens the road to good pay and success.

### You Get A Money Back Agreement

I am so sure that N. R. I. can train you satisfactorily that I will agree in writing to refund every penny of your tuition if you are not satisfied with my Lesson and Instruction Service upon completion.

### Free 64-Page Book of Facts

Mail the coupon now. In addition to the sample lesson, I send my book, "Rich Rewards in Radio." It tells you about the opportunities in Radio, tells you about my Course, what others who have taken it are doing and making. This offer is free to any ambitious fellow over 15 years old. Find out what Radio offers you without slightest obligation. ACT NOW! Mail coupon in an envelope, or paste on a 1c post card.

**J. E. SMITH, President**  
National Radio Institute, Dept. 5AR  
Washington, D. C.

**The Tested Way to BETTER PAY**

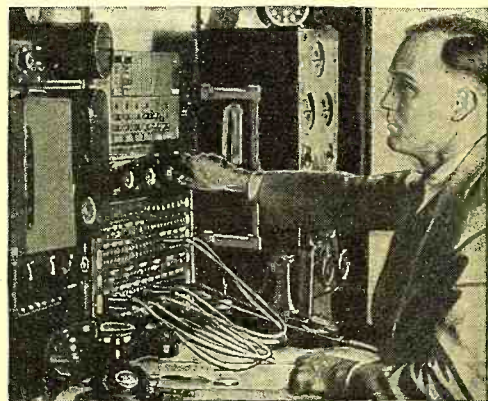

### You Get PRACTICAL Experience with Radio Equipment I GIVE You

I'll show you how to use my special Radio Equipment for conducting experiments and building circuits which illustrate important principles used in such well-known sets as Westinghouse, General Electric, Philco, R. C. A., Victor, Majestic and others. You work out with your own hands many of the things you read in my lesson books. This 50-50 method of training makes learning at home easy, interesting, fascinating, intensely practical. You learn how sets work, why they work, how to make them work when they are out of order. Training like this shows up in your pay envelope—when you graduate you have had training and experience—you're not simply looking for a job where you can get experience.

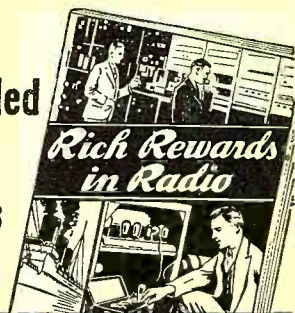

**I have doubled and tripled the salaries of many**

## MAIL THIS NOW!

**J. E. SMITH, President**  
National Radio Institute, Dept. 5AR  
Washington, D. C.

I want to take advantage of your offer. Without obligating me, send me your Free Sample Lesson and your book, "Rich Rewards in Radio."  
*(Please Print Plainly.)*

NAME.....AGE.....  
ADDRESS.....  
CITY.....STATE....."R"



**Clears \$4,500 in 18 Months**

"Before taking your Radio Course I was making \$18 a week. I came here three years ago and in 18 months I made about \$4,500 in Radio. I cannot say too much for the wonderful help I have received from N. R. I."  
**NOEL W. RAY,**  
619 Broad St.,  
Gladsden, Alabama.



**Spare-time Work Pays \$18 A Week**

"I only do spare time Radio work and average \$18 a week. People who in good times would buy a new Radio, now have the old one fixed."  
**STEPHEN J. DRAP-CHATY,**  
407 Wunderlich Ave.,  
Barberton, Ohio.



**Radio Engineer at WSUI**

"Upon graduating I accepted a job as service man, and within three weeks was made Service Manager. This job paid \$40 to \$50 a week. Eight months later I obtained a position as operator with Station KWCR through your Employment Department. Now I am Radio Engineer of WSUI."  
**SYLVANUS J. EBERT,**  
University of Iowa,  
Iowa City, Iowa.



# join BING CROSBY, RICHARD ARLEN AND ADMIRAL BYRD in the thrill of tuning

## MASTERPIECE III

Record Breaking Receiver of All Time



Richard Arlen tuning his MASTERPIECE III

Bing Crosby at the dial of his MASTERPIECE III

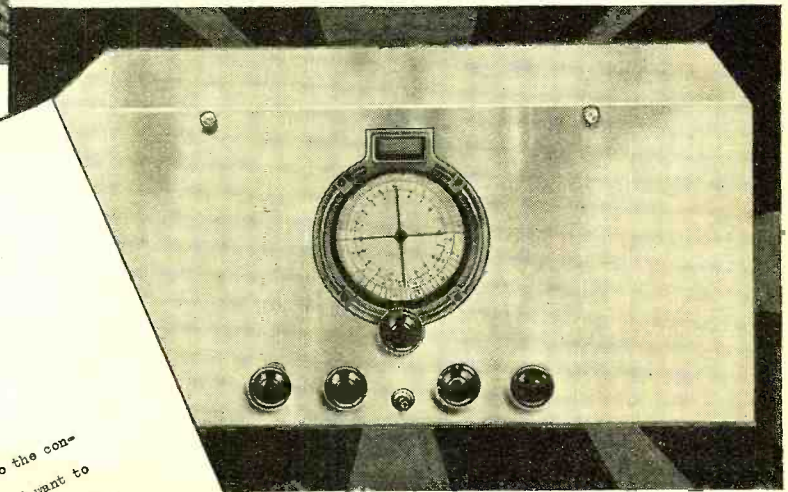

### Band Spread Tuning With New Watch Dial

One big reason why you get more foreign stations with MASTERPIECE III, is the ease with which this receiver locates them. *Actual Band Spread Tuning over all four wave bands!* Simply pull out the knob that operates the watch dial, and the second dial pointer spreads out the crowded short wave band over the whole 180 degree scale. Short wave tuning with MASTERPIECE III is just as easy, simple and rapid as tuning on the broadcast band.

*Bing Crosby*  
Hollywood

October 31, 1934

McMurdo Silver  
3352 N. Paulina Street  
Chicago, Ill.

Dear Mr. Silver:

In spite of certain claims to the contrary by manufacturers of other equipment, I want to assure you that the 109 foreign stations distant more than 5,000 miles recently logged in my shortwave competition with Richard Arlen were all tuned with your Masterpiece III, as were Arlen's. The set, a duplicate of the official receiver used by Admiral Byrd at the South Pole, was used exclusively in that contest.

Please accept my regrets for a misdeed standing beyond my control and my thanks for a thrill that comes once in a lifetime.

Sincerely yours,  
*Bing Crosby*

BC/gw

Someone said that Crosby and Arlen didn't use Masterpiece III. Read this letter.

NEVER before in the history of radio has a receiver been subjected to such demanding test as were the two MASTERPIECE III's used by Bing Crosby and Richard Arlen in their recent international DX contest. Never before has a receiver accomplished so much of the "impossible" as did these two now-famous instruments. Before the contest, many different receivers were considered. Actual performance tests by Paramount Sound Technicians designated MASTERPIECE III as the world's most able radio receiver. Think of it! 122 stations from 28 foreign countries in one week... every station at least 5000 miles distant. Truly, we believe this is the most remarkable record ever achieved. But read what the Radio News technical staff has to say of it in the December issue.

**McMurdo Silver, Inc.**  
3352 N. Paulina Street Chicago, U. S. A.

### TRY IT 10 DAYS FREE

Everyone who has tuned and heard MASTERPIECE III wants to keep it. Byrd, Crosby and Arlen tried it and chose it. Columbia Broadcasting System heard it, tested it, then installed it as official studio receiver in Chicago. You can put MASTERPIECE III to the same tests, under your own reception conditions... without risking one cent of your money. You can try it 10 full days, then send it back if you want to. It's just as simple as that. Check the coupon and mail it at once, for particulars and full details of MASTERPIECE III's most amazing specifications.



McMURDO SILVER, INC.  
3352 N. Paulina Street, Chicago, U. S. A.  
Send for full particulars and specifications of Masterpiece III.

Name .....

Street .....

Town ..... State .....

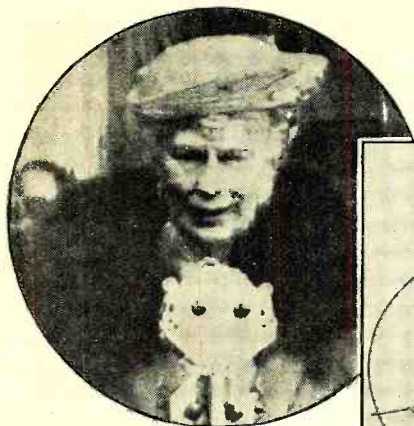

**FLIES OCEAN'S SPAN**

*This photograph, of Queen Mary speaking at Clydebank, "flew" across the Atlantic via radio facsimile*

**TELEVISION AERIALS OF THE FUTURE**

*Odd looking antennas atop an experimental building, in Berlin, serve for television broadcasts*

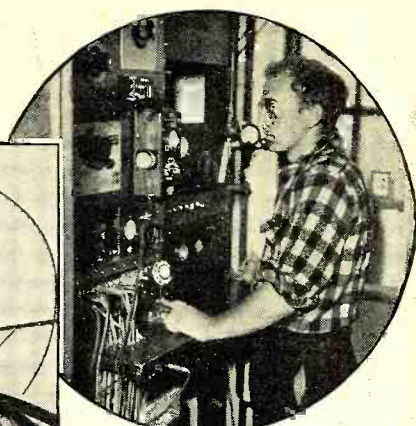
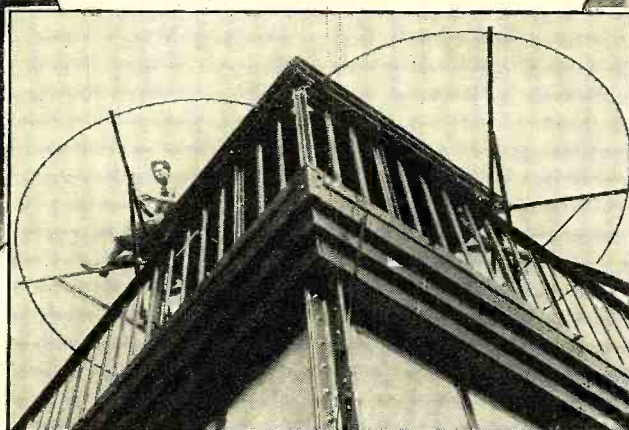

**6,290 FEET HIGH**

*This is the short-wave transmitter at the weather observatory atop Mount Washington, New Hampshire*

**Marconi Talks from Rome**

ROME, ITALY—Guglielmo Marconi, in a recent address from the new station I2RO, told his listeners some interesting facts about the use of micro-waves in radio. He said that he had succeeded in receiving waves of 60 centimeters from distances of 258 kilometers, which was eight times the optical range.

**The Patent Office Sees Good Times Ahead**

WASHINGTON, D. C.—According to the records of the Government Patent Office general conditions certainly are improving. These records show that applications for patents and granted patents are at least 10 percent ahead of the totals for the whole of last year. Patent Office employees state that this is one of the best barometers of general rises in economic conditions.

**Stock Market "Ticker" News by Short Wave**

SPRINGFIELD, MASS.—Twice daily at 12:30 and 5:15 p.m., E.S.T., short-wave station W1XAZ broadcasts the latest stock market flashes in English to all parts of the world.

**Discovers Plot to Seize Radio Plant**

LONDON—Lord Allen startled the House of Lords, recently during a debate on the Seditious Bill, when he made known

**DOTS . . . . .**  
and  
**DASHES**

**Short but Interesting Items from the Month's Radio News the World Over**

the discovery of a movement to seize the British Broadcasting Company's building, in a coup d'état similar to that attempted last year in Vienna. Evidently, the plot was discovered in time to prevent it.

**"Hangover" Relief in Radio Waves**

ARLINGTON, MASS.—The use of radio waves to relieve that "morning after" craving for another drink was reported here, recently, by Dr. Arthur H. Ring. "Radio wave therapy," he stated, "can be used to warm the walls of the stomach causing them to relax and bring comfort to the patient and to eliminate the craving for strong liquor."

**Police Radio for Paris**

PARIS, FRANCE—According to reports, the Paris police are to use radio in the same fashion the New York police are

doing now. A police transmitter is to be placed on the Ile de la Cité and squad cars will cruise about the city while remaining in constant communication with headquarters.

**The New Station in Palestine**

JERUSALEM, PALESTINE—The new station which is to be erected here is now being constructed in Chelmsford, England, by the British Marconi Company. It will work on a wavelength of 441.1 meters, which is the same as that of the British North Regional transmitter. The power will be 20 kilowatts.

**The Broadcast Transmitter for the Fiji Islands**

LONDON, ENGLAND—In order to acquaint the natives of the South Sea Islands with the latest blessings of European civilization in addition to malaria and football, it is planned to build a radio transmitter in Suva. This station will originate its own programs and transmit to Europe and America.

**Radio in the Arctic**

LENINGRAD, U. S. S. R.—The usefulness of radio in the Arctic region has been realized by Soviet communication officials and it has been decided to build seventeen new stations. So far, a network of twenty-two stations exist in the Arctic. They serve ships in the Arctic Ocean and also take a part in research of weather conditions and radio propagation.

**SOME INTERESTING NEW USES FOR RADIO**

*At left: A loudspeaker, as a prize, was won by "Osipowa" for excellent work on the collective farm Ilych of the Western Area, U. S. S. R. Below: Radio amplifiers used at the Hahnemann Hospital, Philadelphia, to study heartbeats. Right: Professor Huffer (right) and assistant making measurements on distant stars by means of photoelectric vacuum-tube amplifier*

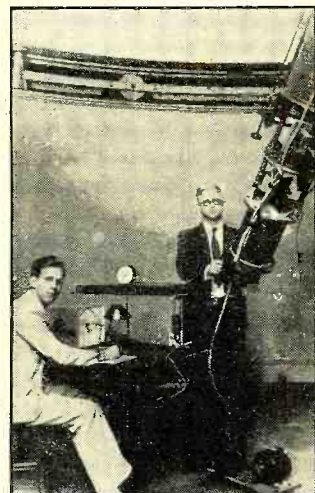

# FREE

## RADIO'S LEADING CATALOG



**NEW AMPLIFIERS**  
A complete new listing of Spring systems and 3 1/2 tube sets, including new amplifier kits, including new amplifier kits in enclosed steel cabinets suitable for relay rack mounting, with built-in 3-channel mixers, 3-channel speakers, new microphone equipment, etc.

**TEST EQUIPMENT**  
The 1935 ALLIED Catalog lists the complete new Supreme line of test instruments including the new Triple Meter, 20 WATT CLASS "AB" Amplifier, etc.

**HIGHEST QUALITY LOWER PRICES BETTER SERVICE**

Send for this great book—over 100 value-packed pages devoted exclusively to radio.

**NEW RECEIVERS**  
The 1935 ALLIED Catalog devotes two special sections to a great listing of new World-wide All-Wave, Dual Wave, Short Wave and Broadcast receivers—Electric, Battery, 32 Volt and Auto models, at new low prices.

**BUILD YOUR OWN**  
More than 15 new Set-Building Kits are listed—covering All-Wave, Dual Wave, Short Wave, electric and battery models—Transmitters, etc. Also special Coil Kit and Diagram listing. We can supply all kits. Write for prices.

**PUBLIC ADDRESS**  
An amazing Public Address array—absolutely different and superior in every detail. Special section lists complete Sound Systems and separate amplifier units for permanent, portable, mobile, rack and panel use, etc.

**AMATEUR GEAR**  
A specialized Short Wave listing answers every need of the Amateur, Set-builder, and Experimenter. New transmitting and receiving equipment—professional receivers, transmitters, antenna gear, all Short Wave parts.

**SERVICE SUPPLIES**  
Page after page is presented exclusively for Radio Servicemen—showing thousands of standard quality radio replacement parts and accessories. Also the latest in test instruments at new low prices. You need this book.

**WORLD-WIDE RADIO**  
New powerful Radio Receivers—all with the latest Purpose Tubes and new Dual selection to choose from. Also new All-Wave Antennas to go with these sets.



**POPULAR NEW KITS**  
Build the famous All-Star All-Wave Superhet or the National 2 Tube Short Wave set—operational in two of the many fine new kits in the great 1935 ALLIED Catalog. Let you new profits building. Kits—use A L—better Kits.

**S. W. HEADQUARTERS**  
The new ALLIED Catalog is packed with recent Amateur developments, including the new National "HRO," the new Ham "Super Pro" and the sensational Super Sky-ride Sky-Knight Transceiver, the famous 2 new High 5-Meter 2-Way gear, etc. ALLIED Headquarters for all leading standard lines. Write for our Catalog. Be sure for our

**WRITE TODAY !**

ALLIED RADIO CORPORATION  
833 W. JACKSON BLVD., CHICAGO., Dept. M.

Please send me:

THE 1935 ALLIED CATALOG.

A complete Parts List for the circuit described in:

.....

Name.....

Address.....

City..... State.....

**Allied Radio CORPORATION**  
833 W. JACKSON BLVD., Chicago, Ill.

# READ WHAT THEY SAY

about this amazingly complete and authoritative Service Manual

VANCOUVER, B. C. "The new line of Yaxley Controls is the greatest improvement ever. The Manual is perfect."

FINDLAY, O. "The work in compiling this information must have taken months. It is splendid."

BOSTON, MASS. "Any service man without the new Yaxley Replacement Volume Control Manual has no business servicing radio sets. He can't be up-to-date in any other way. The controls are swell."

PONTIAC, MICH. "Your volume control catalog is the finest I have seen."

SAN JOSE, CAL. "I have used your volume controls for some time in my servicing and congratulate you on an even finer product."

LANCASTER, O. "Just what the service man needs."

SAN FRANCISCO, CAL. "We have never stocked your controls before, but from now on we are 100% Yaxley."

NEW YORK CITY, N.Y. "Complete isn't the word. The manual is perfect."

DALLAS, TEXAS. "I have been waiting for this for years, wondering why someone didn't do it. The controls are beautiful, simple to install and work better than anything I have ever used."

PASADENA, CAL. "Thanks, the manual is perfect."

NORFOLK, VA. "Congratulations on your progressive move. The Manual is certainly complete and the merchandise better than we believed it could be possible to make. We wish you the best of success."

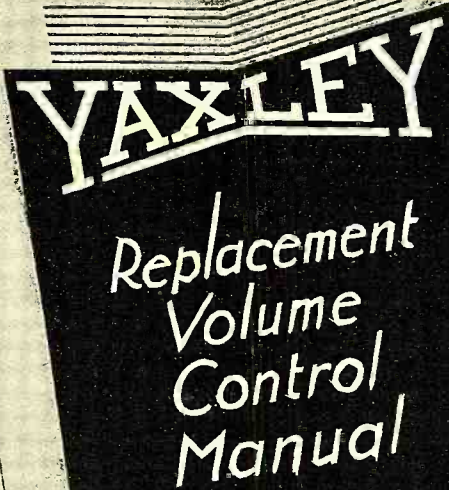

## Mail this Coupon Now

The comments above are just a few picked at random from a tremendous number of enthusiastic letters received from service men the country over. Send the coupon now for this free illustrated book of more than 100 pages that contains invaluable information

and lists the 30 new Yaxley Replacement Volume Controls that will service 98% of the 3200 set models now in existence. Get the full facts about the greatest volume control advance ever made—the biggest boon to service men ever developed.

**YAXLEY MANUFACTURING CO., INCORPORATED**  
Division of P. R. Mallory & Company, Incorporated  
INDIANAPOLIS, INDIANA  
Cable Address: Pelmallo

YAXLEY MANUFACTURING CO., INCORPORATED  
Division of P. R. Mallory & Co., Incorporated  
Indianapolis, Indiana



Gentlemen:

Please send me—absolutely free—a copy of the complete Yaxley Volume Control Manual.

Name.....

Address.....

My Jobber's Name is.....



# Radio News

January, 1935

*Identifying*

## SHORT-WAVE STATIONS

*(The Editor—To You)*

Who is that new station you heard last night? You listened to him for an hour, enjoyed a novel musical program and news items in English, but you couldn't find out what station it was because the announcement was made in a foreign language

**H**UNDREDS of stations to be heard on the short waves—many dialects, queer and interesting music, the lure of “traveling while staying at home,” as well as a wealth of news from all over the world in our own language! These are a few of the things that are attracting every day new listeners by the thousands to this interesting new pastime of listening in to International Short Wave Stations. One of the main difficulties in short-wave reception, however, is *finding out what station you are listening to! Strange voices—foreign tongues!* Whom do they belong to?

One of the most numerous-and-usual types of letters we receive from the new short-wave listeners runs something like this, “I heard a new short-wave station, last night, speaking some foreign language which I could not understand. After that they played queer music. This came in on the 49-meter band. Can you tell me who it was?” Old timers at the short-wave game will at once recognize the earnestness with which such queries are

made, but also the futility of trying to answer them. There would be at least six or seven stations in the above category that might have been heard.

When one considers that there are 24 hours in the day, during any of which a short-wave station may be operating, and that there are thousands of wavelengths on which a station might be transmitting, as many as 35 or 40 on the 49-meter band itself (some of them shared by more than one station) at different times in the day, it will be seen that the problem of station identification is extremely difficult without a well-prepared method of logging.

That was the problem which, nearly 4 years ago, your editor realized *must be solved before short-wave listening could become popular*. That was the problem which every short-wave listener faced, individually, at that time and had to solve for himself. Out of the efforts to solve this problem grew the DX Corner of Radio News, in which at first, was published (*Continued on page 456*)

### FOREIGN VOICES—STRANGE TONGUES!

*These have been some of the main difficulties in the way of identification of short-wave stations by listeners the world over. How they have been solved is told in this short editorial*



# WHAT WE CAN EXPECT FROM SHORT-WAVES THIS YEAR

Here are the forecasts of a number of leading authorities in the field of short-waves. Read what they say about the use of the high-frequencies during the near future

## The Future of International Short-Wave Reception

Charles A. Morrison

President, International DX'ers Alliance

**T**ODAY world-wide reception on the short waves (high frequencies) is an accomplished fact. On a day of average reception conditions with a moderately sensitive all-wave receiver it is possible now, in 1935, for a radio listener to have his choice of the program offerings of many lands. We are accustomed to accepting the marvelous results of modern scientific endeavor in a very prosaic and matter-of-fact manner, so that it is indeed quite easy to lose sight of the fact that world-wide reception for the average layman is a thing of recent growth.

## Large-Scale Acceptance of Short Waves

E. K. Cohan, C.B.A.

**B**ETTER than 80 percent of present-day radio receiver production consists of all-wave models. The president of one of the most prominent manufacturing companies estimates 2,000,000 all-wave receivers are in American consumers' hands now and predicts 10,000,000 in less than five years. 1935 promises to be identified with the first large-scale public acceptance of international short-wave entertainment.

## The Future of World-Wide Short-Wave Reception

Ray H. Manson

Vice President Stromberg-Carlson

**P**RESENT interest in short-wave broadcast reception from foreign countries is

RAY H. MANSON



due to several factors, such as: transmitting of many news reports (in English) of foreign political situations, improvements in entertainment programs, increased signal strength due to use of higher power and directional transmitting antennas, the arranging of time of broadcasts to allow American listeners more hours of evening programs, etc. Plans already announced by foreign broadcasters for better and more programs, scheduled and directed to American listeners, assure the continuation of interest in international short-wave transmission. Improved designs of short-wave receivers and short-wave antennas make for better reception and higher quality of reproduction.

## Can Now Tune In the World

E. H. Scott

President, E. H. Scott Radio Laboratories

**D**URING the past six months the efficiency of all-wave receivers has been developed to such a remarkable degree and the transmitting design engineers have now increased the transmitting range of short-wave stations to the point where I believe it is a certainty that during the next twelve months it will be as commonplace to tune in programs from stations in countries located on the other side of the world as it is to tune in a program of a New York station from Chicago. This prediction is based on experience gained during five and one-half years developing and building nothing but custom-built all-wave receivers.

## Amateur and Commercial S-W Activities Overcoming Racial Prejudices

C. W. Horn

National Broadcasting Co.

**T**HE exchange of programs on short waves, which of course means the exchange of thought and culture, should do a great deal towards overcoming racial and national animosities and should consequently make this world a better place to live in. I am therefore very happy that I was one of the pioneers in this activity and am extremely optimistic as to the good which the international exchange of programs will produce.

## Short-Wave Tuning to Reach "Huge Proportions"

Noel Ashbridge

Chief Engineer, British Broadcasting Corporation

**T**HE greatest interest the British Broadcasting Corporation has in short waves at present is the Empire transmissions from Daventry. The system is immensely successful and remarkable distances are cov-



EDWIN K. COHAN

ered. There is a growing trend in Great Britain at present towards the tuning in of foreign short-wave stations, and this movement is being exploited by radio manufacturers. However, public interest there, in short waves, has not reached the high peak established in America. But the American trend is now being followed and it is quite certain that the short-wave fad will soon reach the point where a huge proportion of British listeners will be tuning in American short-wave features as eagerly as American listeners are now tuning in the British programs.

## The Value of the Short Waves in the Relaying of Special Broadcasts

Wm. Burke Miller

NBC director of special events

**S**HORT-WAVE radio is indispensable to the broadcaster of special events. These events cannot be premeditated, and often it would be almost impossible for any broadcasting company to set up a regular transmitter in time to carry the news over the air. The running of direct wires to an out-of-the-way place would involve an enormous expense, and in some cases would be physically impossible, such as in submarines, boats, airplanes, etc. But with short-wave equipment these places are reached quickly and with ease. The broadcasting stations then relay the short-wave

NOEL ASHBRIDGE





GEORGE MCELRATH

broadcast. The National Broadcasting Company, a pioneer in the development of short-wave apparatus, has two standard types of transmitters: the pack transmitter, which is small and can be carried by one person, and the mobile unit, which is a complete radio station on wheels.

### The Short-Waves in News Broadcasting

Paul W. White

Columbia Broadcasting System

THE short waves are becoming an increasingly important factor in news broadcasting. There are, of course, a number of events in which short waves are virtually a necessity. These include such spectacles as the America's Cup Races and the arrival of the fleet in New York harbor. There remains, however, a further challenge in the use of the short wave for such broadcasts as must be done when wire lines are not immediately available. Broadcasts such as the arrival of fliers at an airport, interviews with survivors of a disaster and fast-breaking stories originating simultaneously at a number of points, depend very largely upon adequate short-wave facilities. Columbia's equipment of this type has been considerably augmented during the past year, and one can confidently predict continued expansion and experimentation in this direction.

PAUL WHITE



## INCREASING POPULARITY FOR 15-200 METERS DURING 1935

Although short-wave broadcasting took hold upon the popular interest to a surprising extent in 1934, the new year is to see an even greater expansion in all short-wave activities

### The Successful Part Short-Waves Played in the Stratosphere Broadcasts

George McElrath

Operations Engineer of the NBC

ONLY through the use of short-wave radio was a two-way conversation made possible between the soaring balloonists and the observers on the ground in the recent Army stratosphere flights. Stratosphere balloons are limited as to the weight they can carry. The light weight and small size of the short-wave equipment make it convenient to place in the gondola. The signals from the navigators were always strong. The men on the ground encountered no difficulty in understanding them during the entire flight, and the rebroadcast over nation-wide networks was very successful.

### International S - W Reception with Freedom from Noise

McMurdo Silver

IT seems safe to say that 1934 has seen reception of short-wave broadcast programs graduate from the realm of pure experimentation to a point where from now on the public will not only expect radio programs of an international character, but will expect them to be entertainment in terms of clarity, freedom from noise, and dependability.

Thus is great incentive given to all-wave receiver designers to perfect commercial all-wave broadcast receivers to a point where they will give the results the public demands and expects—results ordinarily only associated with custom-built laboratory receivers.

### The Future Bright for Short Waves

James Millen

President, The National Co.

PUBLIC interest is becoming aroused by the opportunities for unique entertainment in the high-frequency bands. With the realization of this interest, broadcast set manufacturers have directed their attention toward developing high-frequency receivers capable of international short-wave reception in the hands of the layman. I consider this a development of great promise, not only from the broadcast listener's point of view, but because the greatly enlarged merchandising field may be expected to bring in its wake new materials, new tubes and new knowledge. The day of popular, truly international short-wave reception has dawned, and its future is bright.

### Short-Wave Radio Forging Ahead

Lloyd Hammarlund

Hammarlund Manufacturing Co.

THE production of high-grade short-wave and all-wave receivers has provided an incentive to short-wave broadcasters to increase and improve their facilities. This in turn is producing a greater popular demand for good short-wave sets and the resulting tremendous increase in listeners has again, in turn, resulted in the further improvement of short-wave stations and programs. It is thus assured that this process of improvement will continue—even beyond the point reached in the regular broadcast development because of the international possibilities of the short waves as against the domestic limitations of broadcast-band reception and transmission.

### Urges World Use of Short-Wave Radio for Better Understanding

PHILADELPHIA, PA.—Urging Europe and the United States to iron out their many difficult issues by presenting their divergent points of view to the citizens of their respective countries by short-wave radio, Mr. Larry E. Grubb, President of the Philco Radio and Television Corp. stated that "Diplomats will be ineffectual and leagues of nations worthless until the people of the world arrive at a more neighborly understanding of each other." He also said that, obviously, old methods had failed and the short-wave radio, as a new and personal means for bringing the peoples of the different nations in touch with each other, may solve the difficulties of international relationship.

C. W. HORN



# WHAT 1935 HOLDS FORTH FOR TELEVISION and FACSIMILE

The expressed views of leaders in these fields contain forecasts of near-future public services

## Television to Come Through Facsimile Studies

David Sarnoff  
President R.C.A.

MY faith in the future of radio science is geared to facsimile. The facsimile is the gateway to television. Since Morse invented the telegraph there has been no radical improvement for telegraphy. His alphabet has been in international use ever since, but now we are on the threshold of the first great advance in the art of telegraphy. We are sending pictures and printed matter through the air, and have found the key to speed the traffic. No longer must the message be broken down into hundreds of dots and dashes. It is reproduced by light "brushes" that "paint" it line for line. The next step is to flash the complete picture. The first logical step, of course, is to transmit still pictures and print; that is facsimile radio. The next step will be to send moving pictures; that is television. But before all this could be done a speedy medium of communication had to be found. Marconi discovered it in micro-waves, tiny waves in an ethereal spectrum unaffected by static and fading. The study of television has aided facsimile broadcast and what has been learned by facsimile research has advanced television. I am certain that progress will be extremely rapid.

## Television Could Come Out of the Laboratory Stage: Facsimile Is Ready Now

John V. L. Hogan  
Consulting Engineer

ON the eve of many new developments in radio broadcasting, a natural question arises in the minds of the public. "Why do we not have television broadcast service today?" Of course, the fact is that there are television stations in regular operation at present, but all of them are operating experimentally and none render a true program service for observers. To my mind, the real reason that no such program services are available to broadcast listeners is due to the fact that so far there has been no coordinated plan incorporating the essential elements of such a service. These three elements are: first, an adequate television transmitter having good coverage; second, a source of interesting program material to be televised; and third, a supply of television receivers that can be widely distributed at a reasonable price and which will give sufficiently good reproduction of pictures to satisfy the user's desire for a service rather than merely appealing to his curiosity.

## 1935 to See Actual "Commercial" Television

Dr. Lee de Forest

I AM very confident that 1935 will see actual "commercial" television in the home, giving a 200-line picture, black and white, 18 inches to three feet square. And it will not be by cathode ray. Given this, "flash" facsimile will, of course, be realizable upon the same screen, but whether it will prove commercially profitable to put recorded facsimile in the home appears to me debatable. As to its engineering possibility, there can now be no doubt whatever, by any of at least three proven systems. It will be simply a question of economics.

The numerous long-foreseen problems of how to make television pay its way to popularity must be faced. These can all be successfully solved.

## Big Future for Television Seen

The Rt. Hon. Lord Selsdon, P.C., K.B.E.  
Chairman of the British Post Office Television Committee

I AM visiting the United States to study, and inquire about American television. My mission is to find out just how much progress has been made, inform the British Government about it, and it will subsequently be determined as to what the B.B.C. and British Post Office should do with it insofar as television transmissions are concerned. It is apparent that we must find out all we can about the art of visual broadcasting before applying it on a mass scale. There is a sustaining public interest in England in the present B.B.C. picture transmissions which are, however,

## TELEVISION VS. ECONOMICS

*Dr. Lee de Forest says that television can now be accomplished, technically; that it is merely an economic situation which holds up regular television services*



## STUDIES AMERICAN TELEVISION

*The Rt. Hon. Lord Selsdon visits America on a television mission for the British Government*

still experimental. That there is a big future for television is obvious, but it is difficult to say when it will be accepted by the general radio audience.

## Images at Least 2 Feet Square

William Hoyt Peck

President, Peck Television Corp.

TELEVISION is already here. It meets all the requirements laid down by critics, at least as far as my system is concerned, which will provide images up to two by three feet, with detail comparable to that of home motion pictures, and bright enough to be clearly visible in a room containing two or three floor lamps.

"Mechanical scanning will, in my opinion, be the most popular system. It affords a more sharply defined picture element than does the cathode-ray tube; replacement of light source is necessary at longer intervals and costs but ten cents instead of many dollars.

## Electron Multiplier Helps Television

Dr. R. C. Hergenrother

Television Laboratories, Ltd., Inc.

DEVELOPMENT of completely electronic television methods has reached the point where excellent quality images of

*(Continued on page 443)*

JOHN V. L. HOGAN



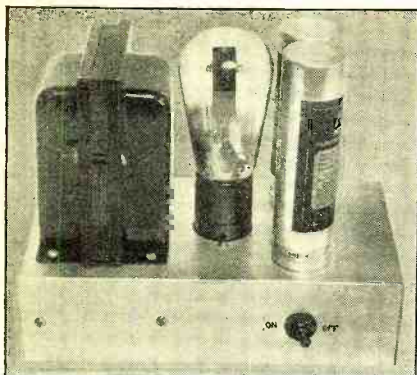

# The "Skyscraper" UNIVERSAL POWER PACK

(For Small S. W. Sets)

Designed to supply filament and plate voltages for humless operation of regenerative receivers employing up to five 6-volt tubes

Dale Pollack and S. G. Taylor

**I**N working up the design of this power pack it was thought desirable to incorporate the necessary features to make it applicable to a wide variety of receivers rather than limit it entirely for use with the "Skyscraper." Thus the design, as presented here, can be used for converting any type of battery-operated receiver to full a.c. operation—providing the receiver employs 6-volt tubes (and not more than five of these). The 6.3-volt filament winding on the transformer is designed to deliver not more than 1.5 amperes. It is this fact that limits the use of the power pack to receivers in which the filament current required does not exceed this figure.

This unit supplies the necessary plate voltage and the filament voltage for the type -80 rectifier and the receiver. The plate supply is 220 volts at 25 ma., and varies somewhat above or below this figure for receivers having smaller or greater current drains. While the high-voltage secondary of the power transformer is rated at 340 volts (55 ma.), this value is, of course, too high for the plate supply of the type of receivers with which the power pack is to be used. Power transformers having a rated output of less than 300 volts are difficult to obtain, and the solution of the problem of using a high-voltage transformer to supply a lower voltage lies in simply eliminating the condenser ordinarily employed across the output of the rectifier and ahead of the first

filter choke. Reference to Figure 1 shows the filter circuit employed. C1 and C2 are the filter condensers of 8 mfd. each. C6 appears in the circuit in the position usually occupied by the first filter condenser. In this case, however, this condenser has the value of only .006 mfd. and is used in conjunction with the choke (RFC) as an r.f. filter—a material aid in eliminating so-called "tunable" hum.

The voltage divider R2 is provided with three adjustable intermediate taps so that three different output voltages are available where needed. In the case of the "Skyscraper" receiver there is a voltage-divider network in the receiver itself, therefore only the high voltage and negative leads need be brought out to the receiver. However, the socket type output terminal of the power pack is one of the 6-prong type. When used with the "Skyscraper," a 6-prong cable plug is employed, but there are only four wires in the cable, the prongs corresponding to two of the intermediate taps of the voltage divider being left unconnected. Where the power pack is intended for permanent use with the "Skyscraper" or with any other receiver having a built-in voltage divider, by-pass

condensers C4 and C5 can be eliminated. Also R2 can be eliminated, entirely, if the voltage-divider network in the receiver is adjustable to permit obtaining the proper plate voltage for the tubes. If not adjustable it will be found desirable to employ the voltage divider, R2, to reduce the output voltage of the power pack, adjusting tap A (Figure 1) until the correct plate voltage required by the receiver is obtained.

The 6.3-volt winding of the transformer T is center-tapped, the center-tap being connected to the B—terminal in the wiring. For this reason the filament wiring of the receiver should be completely (Continued on page 455)

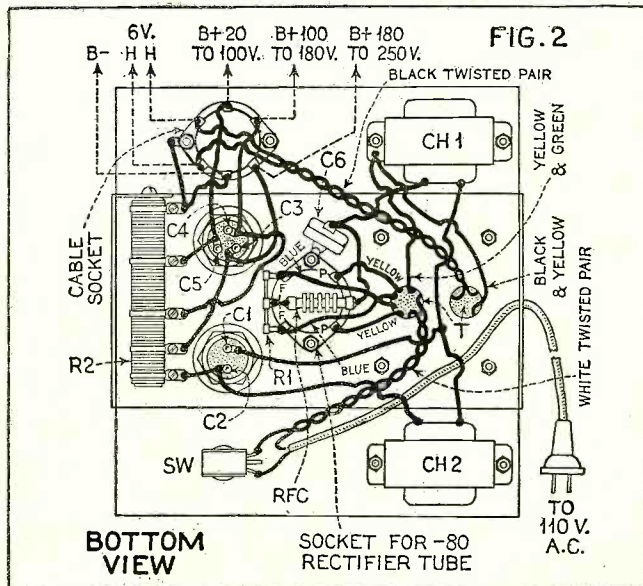
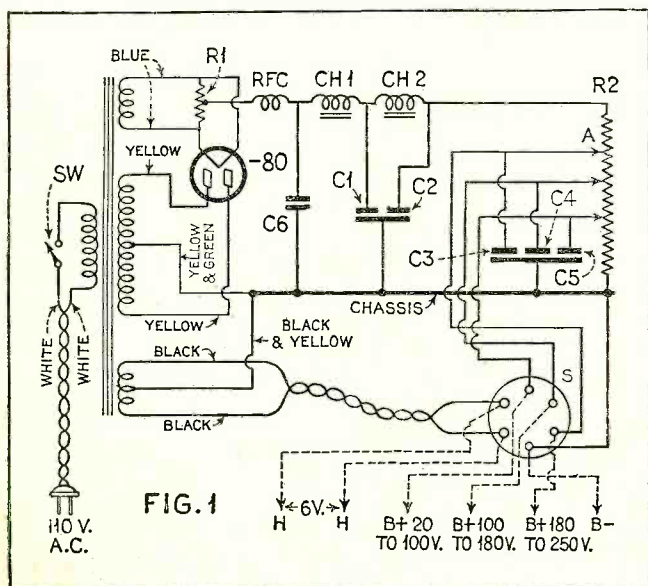
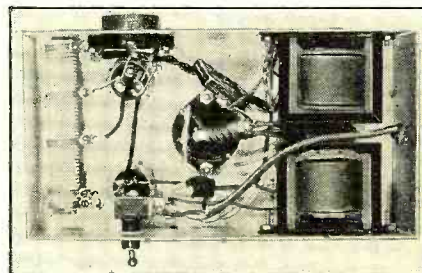

# FIRST AID to INVENTORS

(Getting Your Patent)

This is the third of a new series of articles written exclusively for RADIO NEWS readers, and explaining little-known facts about patents. This article considers the question, "How do I go about getting a patent?"

E. E. Free, Ph.D.

Part Three

THE reader who has followed the two previous articles of this series already knows what I think should be done before he applies for a patent. In this article our assumption is that these things have been done and that a patent is to be applied for. How is this patent to be applied for and obtained? That is the question now before us.

A UNITED STATES patent is an exclusive license issued by the Federal Government, by formal authority of law and through an organization set up for the purpose and called the United States Patent Office. This office is located in Washington, D. C., and is headed by an official called the Commissioner of Patents. The license thus granted lasts for 17 years from the date the patent is issued and gives the inventor the exclusive right to sale (or use) of the invention for that period. After 17 years, the invention becomes open for use by anyone. No patent can be extended more than 17 years except by special act of Congress,

something which very seldom is obtainable.

In the course of years of administration of the United States patent law, the actual document called The Patent has come to consist of three quite definite parts; ordinarily called the specification or description, the claims and the drawings. The specification comes first in the patent and is intended as a complete and accurate description of the invention. The claims follow this, are individually numbered and are intended as the inventor's own statement of exactly what he believes to be new and useful in his invention. The drawings are intended merely to illustrate the description and to make it easier to understand. If the patent covers some-

#### NEW BRITISH INVENTION

*What would you do if you had invented this device? It is called the Zonograph, and is a mechanical radio station finder, the invention of the Englishwoman shown demonstrating the device*

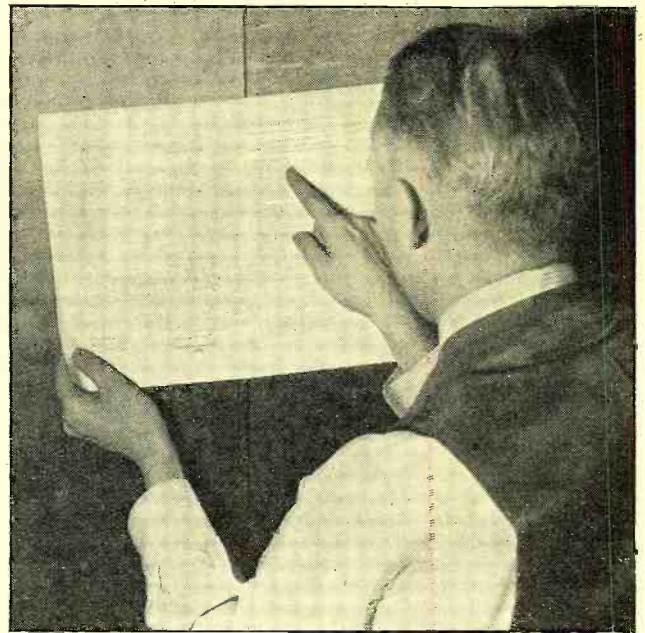
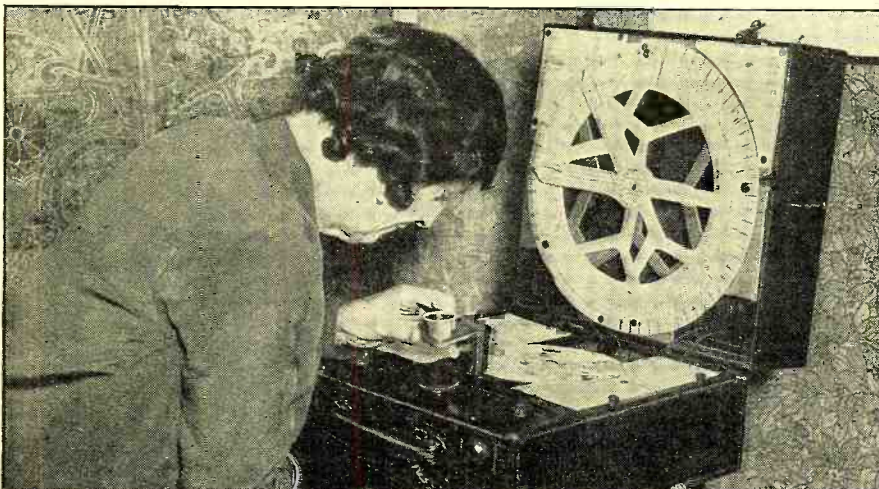

#### THIS MIGHT BE YOUR OWN PATENT

*Here is a copy of an issued U. S. patent. It contains on the left-hand page drawings describing the invention, while on the right-hand page is a written description of the patent and the claims that are "allowed"*

thing which cannot be shown by drawings, these may be omitted.

The preparation of proper specifications and claims is a matter of considerable technical complexity, requiring skill and experience in patent law and involving some far from obvious pitfalls which must be avoided if the patent is to be valid. Nothing in the law requires an inventor to hire a patent attorney, but *much* in common sense. Among the many foolish things which inventors can do probably *none is more foolish than to try to draw up and prosecute patent applications for themselves!*

In the descriptive part of a patent the chief pitfall for the inexperienced probably is the one called "*incomplete disclosure.*" Remember the theory of a patent. It is an inducement to the inventor to make public what he knows. If he refuses, or accidentally fails, to make public all essentials of his invention, the law holds (quite correctly) that the 17-year protection which the patent grants has been obtained improperly and is invalid.

During the war I examined a series of chemical patents, issued several years before, to citizens of a Foreign Power. These patents had been used, ostensibly, in the United States by citizens of that Foreign Power, under direction from home. As a part of the wartime readjustments these patents were taken over by American interests. They were found to be unworkable. Investigation showed that a few essential steps had been left out of the patent specifications. Presumably the object was to obtain what seemed to be patent protection while keeping secret some essentials of the actual process. The patents concerned were held invalid because the disclosures *had been incomplete.*

The rule of the Patent Office is that the description of the invention in the

specification and drawings must be complete and accurate enough so that anyone reasonably acquainted with the field in which the invention lies shall be able to use the patent without further information or instruction. The technical phrase is that the patent must be usable by anyone "skilled in the art." If it is not, court action may declare the patent invalid at any time.

Two common pitfalls exist in interpreting claims. One is the weakness of what sometimes is called a "detail claim." The other is the similar deficiency of what are called "combination claims."

I examined, recently, a patent covering an apparatus for killing insects by certain kinds of rays. The claims covered the apparatus in detail, including the specific shape and construction of a reflector used with it. In my opinion, the patent was virtually worthless. Anyone wishing to avoid the patent could do so by changing some detail of the reflector. The patent's claims were detail claims, covering but *one way out of many possible ways* to do the same job.

As illustration of a weak combination claim I recall a patent covering a combination of a telescope, a photo-electric cell, a special kind of interrupter, a similarly specified type of vacuum-tube amplifier and a special type of electric meter used as a measuring device. None of these devices was patentable *alone*, for all were well-known and old. The job done by the combined contrivance also *was not patentable*. This job had been done before in other ways. The only thing really covered by the patent was a *special combination* of well-known devices used to do a well-known job. By changing even one of these devices an imitator could escape the patent; for example, by using a different type of amplifier or some other kind of indicator in place of the electric meter.

At the opposite extreme of patent values, the strongest kind of claim is the so-called "basic" claim, covering completely some article or process which is entirely new. Since most inventions represent relatively slow developments to which many successive inventors contribute, completely basic claims are extremely rare, but they exist. The original de Forest patent on the three-element vacuum tube was such an instance.

I do not mean to imply that basic claims are necessary to patent value or that detail claims or combination claims are always worthless. There are circumstances in which such limited claims are highly valuable; as well as being the best that you can get. The point merely is that the whole matter of drafting the claims and specifications of a patent, as well as of evaluating these features of a patent already drawn or granted, requires a high degree of expert legal skill.

The proper relation of an inventor and the patent attorney whom he should hire requires the inventor to give the attorney all significant facts concerning the development, nature and use of the invention, as the inventor sees them. It then is the attorney's duty to embody



U. S. PATENT OFFICE

*Here is the patent center of the United States, at Washington, D. C., where all inventions must be filed and passed on by examiners before U. S. patents are granted covering them*

the invention in a proper set of specification, claims and drawings. These documents are drawn up in certain specified forms and are filed (by the attorney) in the Patent Office in Washington, constituting an "application." This application receives a "filing date" and a serial number, assigned by the Patent Office, and proceeds to be studied by a Patent Office official called an "Examiner." Models no longer are required to be filed with the application. Indeed, they are not even accepted unless by special arrangement with the Patent Office.

Only the inventor himself can apply for a patent. The attorney is merely the inventor's agent. If two or more inventors are concerned in the same invention they may apply as joint inventors but one person who assists another with money or other similar aid is *not* a joint inventor. Such financial interests ordinarily are cared for by assignment of all or a part of the patent, which assignment may be recorded in

PATENT OFFICE LIBRARY

*Here is the Scientific Library Room, where searches are made for previous patents that might interfere with the granting of a patent on an invention*



the Patent Office at Washington, D. C.

A patent application must be filed within two years after the publication of any description of the invention or sale of any article or process which the invention covers. If an invention is still being developed and is not described publicly or involved in sales or other use for profit, the filing of patent application sometimes may be delayed for more than two years after the invention is completed, but this may be dangerous. It is a good rule not to delay filing the application more than two years after making the invention without obtaining the advice of a competent patent attorney as to whether or not it is safe to do so.

Filing the patent application does not itself provide protection. It is a common custom to mark articles for sale "patent applied for" or "patent pending." There is no particular objection to this and it may have a certain commercial advantage in scaring off the more timid would-be imitators. It does not prevent imitation nor is the fact that a patent has been applied for any guarantee that it will be granted.

When your patent application has been filed in the Patent Office it must run the gauntlet of examination. This consists of two chief items. First is an examination of the application to see whether both it and the invention it describes meet the various formal requirements of the law and of the Patent Office. Second is a comparison of your invention with similar inventions previously patented in the United States and sometimes with other printed literature, to see whether your invention has been anticipated.

Among the important formal requirements of an invention is that it be patentable, in a somewhat technical meaning of that word. A mere idea is not patentable. A mere mixture of various ingredients is not patentable unless it can be shown that the particular mixture used has some unique and useful property not possessed by other similar mixtures. Many mere mixtures of drugs sold as so-called patent medicines are not really patented but are protected by trade mark. Many other things which seem to the person who thinks of them to be patentable are not so in the meaning of the law. To decide just which features of an invention probably are patentable and which are not is another part of the duty of your patent attorney.

Another (Continued on page 453)

## S.W. PIONEERS Official RADIO NEWS Listen- ing Post Observers

LISTED below by countries are the Official RADIO NEWS Short-Wave Listening Post Observers who are serving conscientiously in logging stations for the DX Corner:

Argentina, J. F. Edbrooke.  
Australia, C. N. R. Richardson, C. Arthur Matthews, A. H. Garth.  
Brazil, W. W. Enete, Louis Rogers Gray.  
British Guiana, E. S. Christiani, Jr.  
British West Indies, E. G. Derrick, Edela Rosa, N. Hood-Daniel.  
Canada, Douglas Wood, Jack Bews, W. H. Fraser, Robert Edkins, Charles Eugene Roy, J. T. Atkinson.  
Canary Islands, Manuel Davin.  
Chile, Jorge Izquierdo.  
China, Baron P. D. N. von Hoynin-gen-Huene.  
Colombia, J. D. Lowe.  
Cuba, Frank H. Kydd, Dr. Evelio Villar.  
Curacao, R. J. Van Ommeren.  
Denmark, Hans W. Priwin.  
Dutch East Indies, A. den Breems  
England, Kenneth Judd, C. L. Wright, John J. Maling, Alan Barber, Donald Burns, L. H. Plunkett-Checkemian, L. H. Colburn, Norman C. Smith and John Parkinson, Norman Nutthall, L. C. Styles, Frederick W. Gunn, R. Lawton, R. Stevens, W. P. Kempster, R. S. Houghton, Harold J. Self.  
France, J. C. Meillon, Jr.  
Germany, Herbert Lennartz.  
Honduras, R. Wilder Tatum.  
Hawaii, O. F. Sternemann.  
India, D. R. D. Wadia.  
Italy, Dr. Guglielmo Tixy.  
Japan, Masall Satow.  
Malta, Edgar J. Vassallo.  
Mexico, Felipe L. Saldafia.  
New Zealand, Dr. G. Campbell MacDiarmid, Kenneth H. Moffatt.  
Norway, Per Torp.  
Philippine Islands, Victorino Leonen.  
Scotland, Duncan T. Donaldson.  
South Africa, C. McCormick, Mike Kruger.  
Spain, Jose Ma. Maranges.  
Switzerland, E. J. de Lopez, Dr. Max Hausdorff.  
Venezuela, Francisco Fossa Anderson.  
Applications for Official Observers in the remaining countries should be sent in immediately to the DX Corner. Listeners outside of the United States who feel that they would like to serve in this capacity are hereby requested to file their applications as soon as possible before final appointments are made.



## S. W. TIME SCHEDULE

LAURENCE M. COCKADAY

THE 22nd installment of the DX Corner for Short Waves features the World Short-Wave Time-Table for 24-hour use all over the world. The list starts at 08 G. M. T., which is 3 a. m., E. S. T., and runs through 07 G. M. T., or 2 a. m., E. S. T., right around the clock. The Time-Table contains a list of short-wave stations, logged during the last month in the RADIO NEWS Westchester Listening Post (in our Editor's home), as well as at other Official RADIO NEWS Short-Wave Listening Posts throughout the world. It provides an hour-to-hour guide for short-wave fans, whether experienced or inexperienced. There is also included a List of Station Locations, giving the wavelength, call letters, frequency, town and country.

### Affiliated DX Clubs

We are hereby placing a standing invitation to reliable DX Clubs to become affiliated with the DX Corner, as associate members acting as advisers on short-wave activities, in promoting short-wave popularity and reception efficiency. A list of associate organizations follows: International DX'ers Alliance, President, Charles A. Morrison; Newark News Radio Club, Irving R. Potts, President; A. W. Opper, Executive Secretary; Society of Wireless Pioneers, M. Mickelson, Vice-President; U. S. Radio DX Club, Geo. E. Deering, Jr., President; the Quixote Radio Club (no officers); the Radio Club Venezolano of Caracas, Venezuela, President, Alberto Lopez. Any DX fan wishing to join any one of these clubs or associations may write for information to the Short-Wave DX Editor, and his letter will be sent to the organization in question. Other clubs who wish to become affiliated should make their application to the Short-Wave DX Editor. Clubs associated with the DX Corner have the privilege of sending in club notes for publication in RADIO NEWS.

### Short-Wave Club News

Mr. Mickelson, vice-president of the Short-Wave Pioneers, sends in the following club news: "From all indications, we are due for a remarkable DX season. New 'catches' are coming in thick and fast. Om. Bragden, radio editor of the New York Sun, has joined our ranks; also YL Alice R. Burke (W9DXX). Anyone who wants dope on the S.W.P. (a club of real old-

timers), address me personally through your editor."

The scribe for the Quixote Radio Club sends in the following club news: "Being mildly DX'ers, the Q.R.C. devotes its efforts primarily to helping listeners derive the utmost enjoyment from their receivers investments. It has achieved noteworthy success in bringing about the co-ordination of schedules to avoid interference, as in the cases of W1XAZ-VK2ME and W8XAL-GSA."

W. H. Reeks sends in the following news notation from the Chicago Short-Wave Radio Club: "Our members meet every two weeks and discuss matters pertaining to short-wave reception. Anyone wanting information regarding membership in the Chicago Short-Wave Radio Club may be addressed by writing to the Secretary, c/o the Short-Wave DX Corner, Radio News."

Sr. Don Alberto Lopez, president of the Radio Club Venezolano, sends us the following rules for that club, asking that they be published: "En Asamblea extraordinaria celebrada en el local del Radio Club Venezolano el día 28 de junio de 1934, fué propuesto por la Junta Directiva y aceptado por unanimidad lo siguiente:

"Los Miembros se dividirán en Miembros Fundadores, Miembros residentes y Miembros afiliados.

(a) Serán denominados Miembros Fundadores, todos los miembros actuales del Radio Club Venezolano, quienes Firmarán un cuadro Caligrafiado que se colocará en el Salón de Sesiones, con cien casillas. También serán Miembros Fundadores los futuros Miembros que manifiesten serlo, hasta llegar a CIEN, de acuerdo con el artículo 4° de los Estatutos.

"Todas los Miembros Fundadores pagarán como cuota de inscripción la cantidad de Bs. 20 (viente bolívares) y gozarán de todos los servicios del Radio Club Venezolano.

"(b) Serán considerados como Miembros residentes, todas los que se inscriban después de haber completado el número de los CIEN Miembros Fundadores y aquellos que manifiesten serlo así, aunque no se haya completado el número de los Fundadores.

"Los Miembros residentes, recibirán su participación de haber sido aceptado por comunicación de la Secretaría y gozarán de todos los servicios del Radio Club Venezolano; pero no firmarán el cuadro caligrafiado, ni percibirán el diploma Litografiado de los fundadores.

"Los Miembros residentes pagarán como cuota de Inscripción la cantidad de Bs. 10 (diez bolívares).

"Los Miembros afiliados serán aquellos que no residan en la sede del Radio Club; no pagarán cuota de inscripción en absoluto pues se toma en cuenta que no podrán dis-

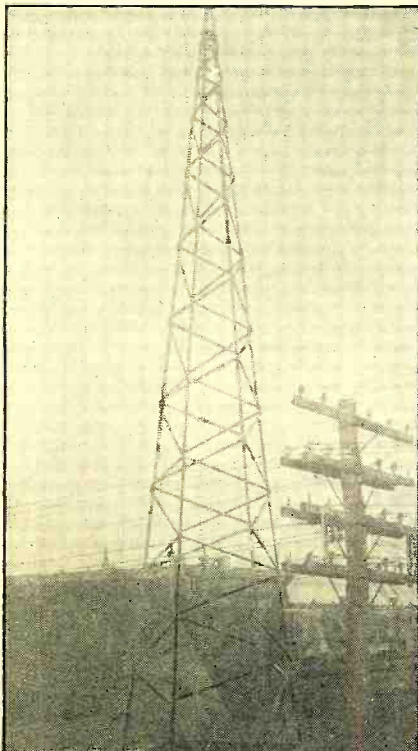

### LISTENING POST TOWER

This is the bolted wooden mast of Short-Wave Observer Charles Nick, of Philadelphia, Pa. It sure gets his antenna up and away from interference



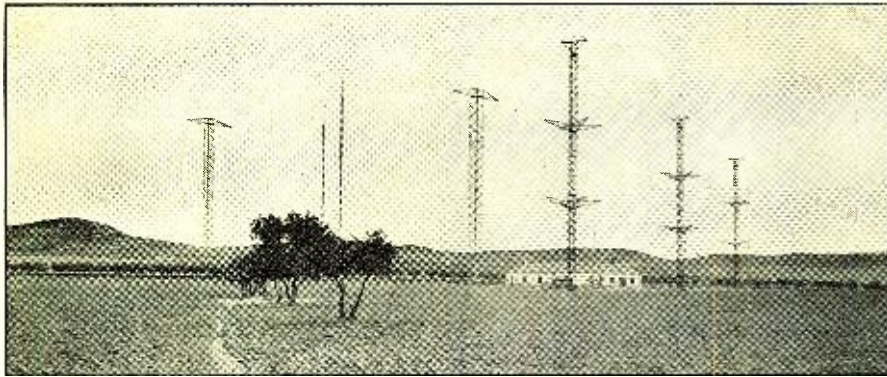

**THE FAMOUS MADRID SHORT-WAVE TRANSMITTER**

*This is the site of the transmitter and antenna system of short-wave station EAQ, which is located at Aranjuez, Spain, rather than directly within the city of Madrid*

(Photo, courtesy, R. H. Tomlinson)

poner de algunos de los servicios que ofrece el Radio Club Venezolano a los residenciados, tales como clases, experimentos que se realicen en el Laboratorio, Biblioteca, &

“Los Miembros fundadores, residentes, y los afiliados, pagarán todos una cuota mensual de Bs. 5 (cinco bolívares) para contribuir al sostenimiento del Radio Club Venezolano.

“Un Miembro de una denominación puede pasar a la inmediata solicitud del interesado y siempre que sea considerado en asamblea.”

Howard Morse, secretary-treasurer of the U. S. Radio DX Club, sends in the following news note: “The club was organized two years ago this month to help people enjoy their DX’ing hobbies. All membership applications and requests for information should be addressed to me c/o the Editor of the DX Corner.”

**Listening Post Observers and Other Fans, Please Note!**

Listed below is this month’s partial information regarding short-wave stations heard and reported by our World-Wide Listening Posts. Can you supply actual Time-Schedules, actual Wavelengths, correct Frequencies and any other information regarding them? There are some hard ones to pull in here, so get busy and try your skill in logging these stations and getting correct information about them. When you are satisfied you are correct, send this information in to the Editor. The list follows:

Who has heard the new Icelandic station scheduled to start the end of last October? COG2 at Lisbon, Portugal, reported as testing 25.18 meters.

PRA3 reported on 49.75 meters. Stations ORG and OPL have been heard testing with one another; ORG is on 15.26 meters and OPL is on 14.97 meters.

JVT, on 44.44 meters; who has their complete schedule? JVT is reported as transmitting instead of JVM week days; the same Listening Post reports JVM on air Sundays only now.

LSQ, Hurlingham, B. A., reported on 15.38 meters, asking for reports.

FZS, 16.33 meters and 25.02 meters; FZR, 18.51 meters and 31.15 meters; FZG, 27.71 meters, are telephony stations at Saigon, Indo-China.

RIM, Tashkent, reported on 19.68 meters. VIY, on 25 meters, has been heard recently, broadcasting the London-Melbourne air races with the same program as VK3ME.

HJ1ABG is a new Barranquilla, Colombia, station on 6042.5 kc.

HIH, San Pedro de Macoris, Dominican Republic, 6814 kc. 9:15-9:45 p.m., irregular.

DJN reported heard on about 15340 kc., 8:45 to 11:30 a.m., E.S.T.

PK1WK (or PEF? or YDA?), 6116 kc., reported at 9:30-10 a.m., E.S.T. Who knows which of these are the correct call letters?

CP2AJ, Ponta Delgada, Azores, 83.3 meters, reported on Wednesday, Saturday, 10 to 11 p.m., G.M.T.

The Peruvian station on 38 meters seems to be off the air. OA4D, Lima, Peru, reported on 51.9 meters. OCN reported on 48.1 meters; OA4B reported on 42 meters; OA4AC still reported on 38 meters; OCT reported on 19.2 meters. These conflicting or partial reports about the Peruvian stations need clarifying.

HCJB reported as changing wavelength from 73 to 36.5 meters.

The following list of stations sometimes all rebroadcast each other and then, follow that, with a regular “hamfest”; some fun! HJ3ABB, PRADO, TIEP, HJ4ABB, HJ4ABE, HJ1ABB, YV5RMO, YV4RC, LO8AB (Buenos Aires).

A powerful station on 10.4 megacycles was heard talking Italian and calling “Hello, Roma” recently at 4:45 p.m., E.S.T.

Why does not anyone hear CNR nowadays; we do not hear it at Westchester. Have received no “info” as to change of schedule or frequency.

How many Australian LPO’s or other listeners hear VK2ME rebroadcasting on 7 meters? They’re there!

VK2ME will send programs dedicated to the British Isles on December 2, 1934, from 6:30 to 7:45, G.M.T., and 14, 15-15:15, G.M.T. (This is about the time this issue appears on the newsstands.—Editor.)

HJA7, Cucuta, Colombia, reported heard on 5400 kc. testing and promising to verify.

Is it HJO or HKO? This station has been variously reported as Bogota, Colombia, 2-3 p.m., E.S.T., as well as 8-9 p.m., E.S.T., on about 23 meters. Which is which, if any?

VWY, Kirkee, India, 31.36 meters, reported heard 9:30 to 10 p.m., E.S.T.

Who is VK3XX, Melbourne, who has been reported by some of our listening posts on about the same frequency as VK3LR?

Shanghai, China, is soon to be heard through XGBA, XGBB, XGBC, XGBD on 13-, 16-, 25- and 31-meter bands. (From when to when? Tune in.)

OPM, heard on 29.58 meters.

HCK, reported as QUITO, Ecuador, on 5815 kc.

HI1A is now using 50 watts (instead of 7½ watts) and they announce frequently in English. We wish more South American stations would do this.

(Continued on page 412)

**S.W. PIONEERS  
Official RADIO NEWS Listening Post Observers**

LISTED below by States are the Official Radio News Short-Wave Listening Post Observers who are serving conscientiously in logging stations for the DX Corner:

- United States of America:
- Alabama, J. E. Brooks; Arizona, George Pasquale; Arkansas, Don Pryor, Jas. G. Moore; California, E. G. DeHaven, C. H. Canning, E. S. Allen, A. E. Berger, Ralph Leavitt, Geo. C. Sholin, Wesley W. London; Colorado, Wm. J. Vette, F. Erich Bruhn; Connecticut, Geo. A. Smith, H. Kemp, Philip Swanson; District of Columbia, Douglas S. Catchim; Florida, E. M. Law, James F. Dechert, Geo. H. Fletcher; Georgia, James L. Davis, Ch. H. Armstrong, Guy R. Bigbee, John McCauley; Idaho, Bernard D. Starr, Lawrence Swenson; Illinois, Phillip Simmons, E. Bergeman, Robert L. Weber, Floyd Waters, Chas. A. Morrison; Indiana, Freeman C. Balph, J. R. Flannigan, Henry Spearing; Iowa, J. Harold Lindblom; Kansas, C. W. Bourne, Wm. Schumacher; Kentucky, Wm. A. McAlister, George Krebs; James T. Spalding, Charles Miller; Louisiana, Roy W. Peyton; Maine, R. I. Keeler; Maryland, Howard Adams, Jr., James W. Smith, J. F. Fritsch; Massachusetts, Armand A. Boussy, J. Walter Bunnell, Harold K. Miller, Donald Smith, Elmer F. Orne, Arthur Hamilton, Roy Sanders; Michigan, Stewart R. Ruple; Minnesota, Dr. G. W. Twomey, M. Mickelson; Mississippi, Dr. J. P. Watson, Mrs. L. R. Ledbetter; Missouri, C. H. Long; Montana, Henry Dobrovalny; Nebraska, P. H. Clute, G. W. Renish, Jr., Harold Hansen; New Hampshire, P. C. Atwood, A. J. Mannix; New Jersey, William Dixon, R. H. Schiller, William F. Buhl; New Mexico, G. K. Harrison; New York, Capt. Horace L. Hall, S. G. Taylor, John M. Borst, Wm. C. Dorf, R. Wright, I. H. Kattell, Donald E. Bame, Albert J. Leonhardt, Wm. Kocnlein, Edmore Melanson, H. S. Bradley; Nevada, Don H. Townsend, Jr.; North Carolina, H. O. Murdoch, Jr., W. C. Couch, E. Payson Mallard; North Dakota, Dr. F. C. Naegeli; Ohio, Oker Radio & Electric Shop, R. W. Evans, C. H. Skatzes, Donald W. Shields, Albert E. Emerson, Samuel J. Emerson, Clarence D. Hall; Oklahoma, H. L. Pribble, Robert Woods; Oregon, Geo. R. Johnson, Virgil C. Tramp; Pennsylvania, Edward C. Lips, K. A. Staats, C. T. Sheaks, George Lilley, John A. Leininger, F. L. Stitzinger, Hen. F. Polm, Chas. Nick; South Carolina, Edw. F. Bahan, Ben. F. Goodlett; South Dakota, Paul J. Mraz; Tennessee, Charles D. Moss, Adrian Smith; Texas, Heinie Johnson, Bryan Scott, John Stewart; Utah, Harold D. Nordeen; Vermont, Joseph M. Kelley, Eddie H. Davenport; Virginia, Gordon L. Rich, G. Hampton Allison, D. W. Parsons; Washington, A. D. Golden, Glenn E. Dubbe, Chas. G. Payne; West Virginia, Kenneth Boord, R. E. Sumner; Wisconsin, Willard M. Hardell, Walter A. Jasiorowski.

Applications for Official Observers in the remaining States should be sent in immediately to the DX Corner. Listeners outside of the United States who feel that they would like to serve in this capacity are also requested to file their applications as soon as possible before final appointments are made.

**CAPT. STEVENS SALVAGES  
“STRATO” BATTERY BOX**



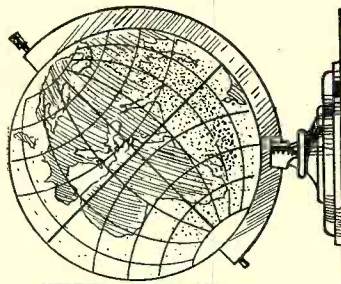

# WORLD SHORT WAVE TIME-TABLE

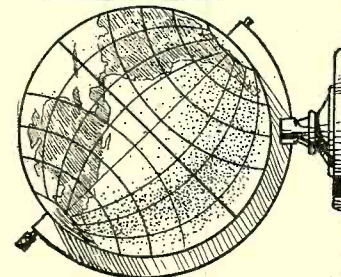

The scheduling of short-wave broadcasting stations listed below includes only those that are received best in RADIO NEWS LISTENING PGSTS. This new schedule is from 8 G. M. T. right around the clock. Both wavelength and frequency are noted for each station. Station locations are found on page 412.

### International Short-Wave

**Wavelengths in Meters**      **Call Letters**      **Frequency in K.C.**

08 G. M. T. 3 A. M. E. S. T.

25.5 Irregular JVM GSD 11750  
 27.9 Irregular JVN 10660  
 28.1 Irregular JVS 9840  
 30.4 Irregular VK3LR 9580  
 31.3 Except Sun. Irregular LKJ1 9540  
 31.4 Sun. GSB 9510  
 31.5 Irregular JVT 6750  
 38.0 Irregular JVS 7880  
 44.5 Irregular JVT 6750  
 48.9 Irregular OER2 6122  
 49.3 Irregular VO7LO 6060  
 49.4 Irregular CON 6024  
 49.8 Mon., Fri. RV15 4273  
 70.2

09 G. M. T. 4 A. M. E. S. T.

19.7 Sun. DJB 15200  
 25.5 GSD 11750  
 27.9 JVM 10660  
 28.1 JVS 9840  
 30.4 JVN 9580  
 31.2 VK2ME 6072  
 31.3 Except Sun. Irregular VK3LR 6024  
 31.4 Sun. LKJ1 6000  
 31.5 GSB 4273  
 38.0 Irregular JVT 6750  
 44.5 Irregular JVT 6750  
 48.9 Irregular OER2 6122  
 49.8 Mon., Fri. CON 6024  
 49.9 Ex. Tu., Th., Sat. RV59 6000  
 70.2

10 G. M. T. 5 A. M. E. S. T.

19.7 Sun. DJB 15200  
 19.8 Except Sun. HVI 15123  
 25.5 GSD 11750  
 27.9 JVM 10660  
 28.1 JVS 9840  
 30.4 Irregular JVN 9580  
 31.2 VK2ME 6072  
 31.3 Except Sun. VK3LR 6024  
 31.4 Sun. LKJ1 6000  
 31.5 GSB 4273  
 38.0 Irregular JVT 6750  
 44.5 Irregular JVT 6750  
 48.9 Irregular OER2 6122  
 49.8 Mon., Fri. CON 6024  
 49.9 Ex. Tu., Th., Sat. RV59 6000  
 70.2

### 11 G. M. T. 6 A. M. E. S. T.

48.9 Except Sun. ZTJ 6122  
 49.3 Irregular OER2 6072  
 49.4 Mon., Wed., Fri. VO7LO 6060  
 49.8 Mon., Wed., Thur. ZHI 6012  
 50.2 Sun. HVI 5969  
 52.9 XOAJ 5660  
 70.2 RV15 4273

14.2 LSN 21020  
 19.8 GSC 17790  
 25.1 Sun. RNE 15140  
 27.9 Sun. IVM 11924  
 28.1 Irregular JVN 10660  
 30.4 Irregular JVS 9840  
 31.2 Sun. VK2ME 6072  
 31.3 Except Sun. VK3LR 6024  
 31.4 Sun. WIXAZ 6060  
 31.5 Irregular VUB 9570  
 31.4 Irregular LKJ1 6072  
 31.5 Wed., Sat. VK3ME 9540  
 38.0 Irregular JVR 7880  
 48.9 Tu., Fri., Sun. ZGE 6130  
 48.9 Except Sun. ZTJ 6122  
 49.3 Irregular OER2 6072  
 49.4 Mon., Wed., Fri. PK1WK, PEF? 6116  
 49.8 Mon., Wed., Thur. VO7LO 6060  
 49.8 Mon., Wed., Thur. W8XAL 6060  
 50.1 Ex. Sun. ZHI 5984  
 70.2 XOAJ 5660  
 RV15 4273

### 12 G. M. T. 7 A. M. E. S. T.

13.9 W8XK 21540  
 14.2 LSN 21020  
 16.8 GSC 17790  
 16.8 Ex. Tues., Wed. PHI summer only 17775  
 16.8 XGR 17760  
 19.6 FVA 15243  
 19.6 Except Tu., Wed. PCI 15220  
 19.8 GSB 15140  
 23.3 Sun. CNR 12830  
 24.8 Sun. CTICT 12082  
 25.5 Except Tues., Wed. PHI 11730  
 26.0 XGR 11530  
 27.9 JVM 10660  
 28.1 JVS 9840  
 31.2 Except Sun. VK2ME 6072  
 31.3 Irregular VK3LR 6024  
 31.4 Sun. WIXAZ 6060  
 31.5 Irregular VUB 9570  
 31.8 LKJ1 6072  
 31.8 GSB 6000  
 31.8 RV15 4273

13.9 W8XK 21540  
 14.2 LSN 21020  
 16.8 GSC 17790  
 16.8 Ex. Tues., Wed. PHI summer only 17775  
 16.8 XGR 17760  
 19.6 FVA 15243  
 19.6 Except Tu., Wed. PCI 15220  
 19.8 GSB 15140  
 23.3 Sun. CNR 12830  
 24.8 Sun. CTICT 12082  
 25.5 Except Tues., Wed. PHI 11730  
 26.0 XGR 11530  
 27.9 JVM 10660  
 28.1 JVS 9840  
 31.2 Except Sun. VK2ME 6072  
 31.3 Irregular VK3LR 6024  
 31.4 Sun. WIXAZ 6060  
 31.5 Irregular VUB 9570  
 31.8 LKJ1 6072  
 31.8 GSB 6000  
 31.8 RV15 4273

### 13 G. M. T. 8 A. M. E. S. T.

49.0 Thurs., Fri., Sat. PK1WK, PEF? 6116  
 49.1 Irregular VE9GW 6096  
 49.3 Irregular OER2 6072  
 49.4 Mon., Wed., Thu. W8XAL 6060  
 49.8 Mon., Wed., Thu. ZHI 6012  
 49.9 Sun. HTX 6000  
 50.1 Ex. Sun. TGX 5984  
 52.9 XOAJ 5660  
 70.2 RV15 4273

13.9 LSN 21540  
 14.2 LSN 21020  
 16.8 PHI summer only 17775  
 16.8 DJE 17760  
 16.8 CP5 15308  
 19.6 FVA 15243  
 19.6 Except Tues., Wed. PCI 15220  
 19.7 DJB 15200  
 19.8 GSF 15140  
 23.3 Sun. CNR 12830  
 24.8 Sun. CTICT 12082  
 25.1 Sun. RNE 11924  
 25.5 PHI 11730  
 26.0 XGR 1530  
 31.2 Sun. VK2ME 6072  
 31.3 WIXAZ 9570  
 31.4 DJA 9560  
 31.5 LKJ1 9510  
 31.8 GSB 9415  
 49.0 Sun. ZTJ 6116  
 49.1 Irregular PK1WK, PEF? 6072  
 49.3 Irregular VE9GW 6096  
 49.4 Thurs., Sat. OER2 6072  
 49.4 Thurs. VO7LO 6060  
 49.8 Mon., Wed., Thur. W8XAL 6060  
 52.9 Irregular ZHI 6012  
 70.2 XOAJ 5660  
 RV15 4273

### 14 G. M. T. 9 A. M. E. S. T.

13.9 W8XK 21540  
 14.2 LSN 21020  
 16.8 W3XAL 17780  
 16.8 PHI summer only 17775  
 16.8 CP5 15308  
 19.6 FVA 15243  
 19.6 Except Tues., Wed. PCI 15220  
 19.7 DJB 15200  
 19.8 GSF 15140  
 23.3 Sun. CNR 12830  
 24.8 Sun. CTICT 12082  
 25.1 Sun. RNE 11924  
 25.5 PHI 11730  
 26.0 XGR 1530  
 31.2 Sun. VK2ME 6072  
 31.3 WIXAZ 9570  
 31.4 DJA 9560  
 31.5 LKJ1 9510  
 31.8 GSB 9415  
 49.0 Sun. ZTJ 6116  
 49.1 Irregular PK1WK, PEF? 6072  
 49.3 Irregular VE9GW 6096  
 49.4 Thurs., Sat. OER2 6072  
 49.4 Thurs. VO7LO 6060  
 49.8 Mon., Wed., Thur. W8XAL 6060  
 52.9 Irregular ZHI 6012  
 70.2 XOAJ 5660  
 RV15 4273

13.9 W8XK 21540  
 14.2 LSN 21020  
 16.8 W3XAL 17780  
 16.8 PHI summer only 17775  
 16.8 CP5 15308  
 19.6 FVA 15243  
 19.6 Except Tues., Wed. PCI 15220  
 19.7 DJB 15200  
 19.8 GSF 15140  
 23.3 Sun. CNR 12830  
 24.8 Sun. CTICT 12082  
 25.1 Sun. RNE 11924  
 25.5 PHI 11730  
 26.0 XGR 1530  
 31.2 Sun. VK2ME 6072  
 31.3 WIXAZ 9570  
 31.4 DJA 9560  
 31.5 LKJ1 9510  
 31.8 GSB 9415  
 49.0 Sun. ZTJ 6116  
 49.1 Irregular PK1WK, PEF? 6072  
 49.3 Irregular VE9GW 6096  
 49.4 Thurs., Sat. OER2 6072  
 49.4 Thurs. VO7LO 6060  
 49.8 Mon., Wed., Thur. W8XAL 6060  
 52.9 Irregular ZHI 6012  
 70.2 XOAJ 5660  
 RV15 4273

### 15 G. M. T. 10 A. M. E. S. T.

31.3 Except Sun. VK3LR 6072  
 31.3 WIXAZ 6060  
 31.4 DJA 6072  
 31.4 Irregular LKJ1 6072  
 31.5 Irregular GSB 9540  
 31.5 Except Sat., Sun. PLY 9415  
 48.9 ZTJ 6122  
 49.0 PK1WK, PEF? 6116  
 49.0 VE2RC 6112  
 49.0 VE9HX 6109  
 49.0 VUC 6109  
 49.1 Irregular VE9GW 6096  
 49.1 Thurs., Fri., Sat. W9XAA 6080  
 49.3 Sun. and Irregular OER2 6072  
 49.3 W8XAL 6060  
 49.4 COC 6000  
 70.2 RV15 4273  
 80.0 Sun. CTICT 3750

13.9 W8XK 21540  
 14.2 LSN 21020  
 16.8 PHI summer only 17775  
 16.8 DJE 17760  
 16.8 CP5 15308  
 19.6 FVA 15243  
 19.6 Except Tues., Wed. PCI 15220  
 19.7 DJB 15200  
 19.8 GSF 15140  
 23.3 Sun. CNR 12830  
 24.8 Sun. CTICT 12082  
 25.1 Sun. RNE 11924  
 25.5 PHI 11730  
 26.0 XGR 1530  
 31.2 Sun. VK2ME 6072  
 31.3 WIXAZ 9570  
 31.4 DJA 9560  
 31.5 LKJ1 9510  
 31.8 GSB 9415  
 49.0 Sun. ZTJ 6116  
 49.1 Irregular PK1WK, PEF? 6072  
 49.3 Irregular VE9GW 6096  
 49.4 Thurs., Sat. OER2 6072  
 49.4 Thurs. VO7LO 6060  
 49.8 Mon., Wed., Thur. W8XAL 6060  
 52.9 Irregular ZHI 6012  
 70.2 XOAJ 5660  
 RV15 4273

### 16 G. M. T. 11 A. M. E. S. T.

31.3 Except Sun. VK3LR 6072  
 31.3 WIXAZ 6060  
 31.4 DJA 6072  
 31.4 Irregular LKJ1 6072  
 31.5 Irregular GSB 9540  
 31.5 Except Sat., Sun. PLY 9415  
 48.9 ZTJ 6122  
 49.0 PK1WK, PEF? 6116  
 49.0 VE2RC 6112  
 49.0 VE9HX 6109  
 49.0 VUC 6109  
 49.1 Irregular VE9GW 6096  
 49.1 Thurs., Fri., Sat. W9XAA 6080  
 49.3 Sun. and Irregular OER2 6072  
 49.3 W8XAL 6060  
 49.4 COC 6000  
 70.2 RV15 4273  
 80.0 Sun. CTICT 3750

13.9 W8XK 21540  
 14.2 LSN 21020  
 16.8 PHI summer only 17775  
 16.8 DJE 17760  
 16.8 CP5 15308  
 19.6 FVA 15243  
 19.6 Except Tues., Wed. PCI 15220  
 19.7 DJB 15200  
 19.8 GSF 15140  
 23.3 Sun. CNR 12830  
 24.8 Sun. CTICT 12082  
 25.1 Sun. RNE 11924  
 25.5 PHI 11730  
 26.0 XGR 1530  
 31.2 Sun. VK2ME 6072  
 31.3 WIXAZ 9570  
 31.4 DJA 9560  
 31.5 LKJ1 9510  
 31.8 GSB 9415  
 49.0 Sun. ZTJ 6116  
 49.1 Irregular PK1WK, PEF? 6072  
 49.3 Irregular VE9GW 6096  
 49.4 Thurs., Sat. OER2 6072  
 49.4 Thurs. VO7LO 6060  
 49.8 Mon., Wed., Thur. W8XAL 6060  
 52.9 Irregular ZHI 6012  
 70.2 XOAJ 5660  
 RV15 4273

### 17 G. M. T. 12 A. M. E. S. T.

13.9 W8XK 21540  
 14.2 LSN 21020  
 16.8 W3XAL 17780  
 16.8 PHI summer only 17775  
 16.8 CP5 15308  
 19.6 FVA 15243  
 19.6 Except Tues., Wed. PCI 15220  
 19.7 DJB 15200  
 19.8 GSF 15140  
 23.3 Sun. CNR 12830  
 24.8 Sun. CTICT 12082  
 25.1 Sun. RNE 11924  
 25.5 PHI 11730  
 26.0 XGR 1530  
 31.2 Sun. VK2ME 6072  
 31.3 WIXAZ 9570  
 31.4 DJA 9560  
 31.5 LKJ1 9510  
 31.8 GSB 9415  
 49.0 Sun. ZTJ 6116  
 49.1 Irregular PK1WK, PEF? 6072  
 49.3 Irregular VE9GW 6096  
 49.4 Thurs., Sat. OER2 6072  
 49.4 Thurs. VO7LO 6060  
 49.8 Mon., Wed., Thur. W8XAL 6060  
 52.9 Irregular ZHI 6012  
 70.2 XOAJ 5660  
 RV15 4273

(Continued on next page)





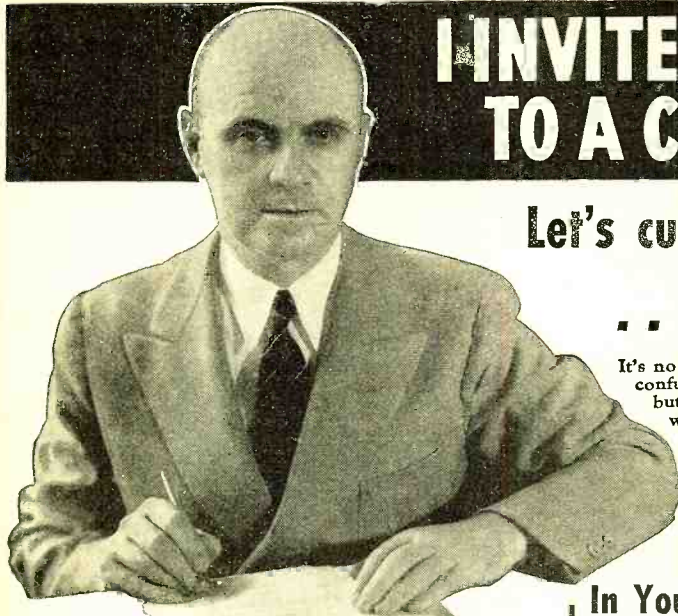

**E. H. SCOTT**  
designer and custom-builder of Super-powered Radio Receivers since 1924

# I INVITE THE RADIO INDUSTRY TO A COMPETITIVE TEST

Let's cut out the "bunk" in radio selling  
... here's my proposition!

It's no wonder that you, as the prospective buyer of an all-wave radio receiver, are confused by all the hue and cry of various manufacturers. Obviously, there can be but one receiver that actually deserves the title "Best!" But how are you to know which one? My suggestion to you—and my challenge to the radio industry—is that you be allowed to find out for yourself by actual trial in your own home. I have sufficient confidence in the superiority of the SCOTT ALL-WAVE XV—above any other all-wave receiver on the market today—to abide willingly by your findings.

## YOU Make This Test . .

In Your Own Home—You to be the Final Judge!

Get a SCOTT ALL-WAVE XV—direct from the Laboratory where it is custom-built—install it in your home and test it side by side with any other all-wave receiver in the world. If, at the end of thirty days' competitive trial you are not entirely satisfied that the SCOTT ALL-WAVE XV brings in more stations, from greater distances, with more volume and better tone, on both the short waves and the broadcast band, than any other all-wave receiver built, you can return it without question. If it fails in any way to deliver exactly the performance claimed for it, the trial doesn't cost you a dime. This is a clean-cut proposition—there are no "ifs," "ands" or "buts" about it.

**HERE ARE  
A FEW REASONS WHY I DARE  
MAKE THIS BOLD OFFER**

Primarily because I know that the SCOTT ALL-WAVE XV is built with greater care and technical exactness than any other all-wave radio receiver in the world ◊ Because SCOTT receivers are giving superlatively fine service to owners in every state in the U. S. A. and 118 foreign countries ◊ Because I have personally tested SCOTT receivers for distance reception in the farthest corners of the world under almost every possible climatic condition ◊ Because I have been making all-wave receivers exclusively for nearly six years ◊ Because SCOTT receivers hold more authenticated records for distance reception than any other receiver in the world ◊ Because the SCOTT ALL-WAVE XV is the most thoroughly tested receiver ever marketed ◊ Because the laboratories in which the SCOTT ALL-WAVE XV is built are equipped with the most accurate and delicate measuring devices known to the radio world, on which each receiver must show perfection ◊ Because I believe that the prospective all-wave radio buyer deserves a square deal.

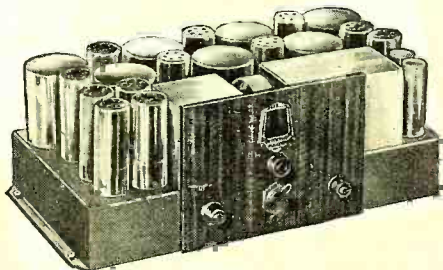

*Custom-built*  
**SCOTT  
ALL-WAVE XV**

## Don't be "Sold" a Radio—BUY it on Facts

Disregard all claims—remember that adjectives and fancy phrases can be used by anyone. Your investment in an all-wave receiver is a sizeable one, and deserves serious consideration. Make the receiver you finally select prove itself in actual operation over a long enough period of time to be conclusive.

## You Can't Buy Custom-Built Quality for \$39.50 or \$59.50

Radio receivers can be built by only two methods. One is the "production line" system where sets are turned out cheaply in great volume. The other is the custom-building system, where exquisite care and micrometrically exact technical handcraft goes into the slow and painstaking construction of each individual receiver. Probably the SCOTT ALL-WAVE XV is the only all-wave receiver on the market today that can honestly lay claim to the right to be called "custom-built," because it is the only one entirely built with scientific precision, designed and sold in its manufacturer's own technical laboratories. Your own judgment will tell you that such construction can't be accomplished at a selling price of \$39.50, \$59.50, or \$79.50—particularly when to manufacturing costs must be added the expenses of liberal profit to jobbers and dealers.

## Dollar for Dollar—the SCOTT ALL-WAVE XV Is the Biggest Value in All-Wave Radio Today

If you could look at the "insides" of other all-wave receivers, you immediately would see why the SCOTT ALL-WAVE XV is such a big value, even if you knew absolutely nothing about radio construction. You would find ample evidence of thoughtful, technically perfect building in the clean-cut, orderly parts assembly of the SCOTT ALL-WAVE XV. You would find oversize and overstrength construction everywhere—tuning condensers, for instance, that are more than twice as large and correspondingly more sturdy and lastingly accurate. In short, you would find innumerable points of superiority that would instantly explain to you why this is the only all-wave receiver given a five-year warranty by a responsible manufacturer. Why not take advantage of the opportunity you are offered of making an actual convincing test yourself through side-by-side comparison of any other receiver, during a thirty-day trial period. Send the coupon NOW for complete details.

**E. H. SCOTT RADIO LABORATORIES, INC.**  
4440 Ravenswood Ave. Dept. 5A5 Chicago, Illinois

**GET COMPLETE DETAILS OF THIS AMAZING PLAN**

Mail this coupon at ONCE for full information about the SCOTT ALL-WAVE XV, including technical data, PROOF of every claim for superiority, and particulars about our 30-day trial offer.

E. H. Scott Radio Laboratories, Inc.  
4440 Ravenswood Ave., Dept. 5A5  
Chicago, Ill.

Send me at once all particulars regarding the SCOTT ALL-WAVE XV, and of your 30-day trial offer for competitive test.

Name.....

Address.....

City.....

State.....

**MAIL THIS  
COUPON NOW**



SOUTHERN OBSERVER'S POST  
This is the listening post of John McCarley at Decatur, Georgia

### The DX Corner (Short Waves)

(Continued from page 407)

HKE, Bogota, Colombia, reported on 41.55 meters, 6-7 p.m., E.S.T.

Has anyone heard TI4NRH back on the air?

PRADO, TI2EP and a few other South American stations talk to HJ1ABB and others, back and forth, after 10 p.m., E.S.T. A very interesting circle!

XIA, reported as being heard as the call letters of a Mexico City station on about 40 meters.

DDAS reported as the steamship *Bremen*. A reader asks, "Who is VLK?"

Another reader asks "Who is NAVM?" Still another reader reports RV14 as testing on 43.2 meters.

Here is some partial information on Javanese station YDA, reported as Bandoeng, Java, 6116 kc, YDA2, Batavia, Java, on 4382 kc. (same schedule as YDA). YDB, Sourabaya, Java, 6136 kc., to start transmissions January 1st. YDB2, Semarang, Java, 4360 kc., to start January 1st. PK1WK reported by many listeners as Bandoeng, Java, and changing wavelength to 3400 kc., 9:30-10:30 p.m., E.S.T. (According to our records at the Westchester listening post, we can find no such call letters listed as PK1WK).

HJY reported as Bogota, Colombia, 30.21 meters, playing music.

L.P.O.'s! Keep your eyes open for the new German stations at Zeesen, reported as starting on a new schedule around Christmas, 1934. No schedule has been procurable as yet. Here they are: DJM, 49.35 meters; DJN, 31.45 meters; DJO, 25.43 meters; DJP, 25.31 meters; DJQ, 19.63 meters; DJR, 19.56 meters. Some of the stations have been heard, irregularly, at our Listening Posts, with 8 kw. power. There will probably be three stations on the air at a time.

Four new transmitters (20 kw.) are scheduled to start in Rome, December 31st. Calls, schedules, etc., have not yet been determined. Watch out for these. They will announce as "La Voce di Roma." Their testing frequencies are reported as follows: 25.4 meters, 42.38 meters, 48.7 meters, 49.3 meters, 49.46 meters, 52.4 meters, 53 meters, 54.01 meters. Listening Posts who get this to us first will be ac-

### Station Locations

Wave-length Meters	Call Letters	Frequency Kc.	City Country	Wave-length Meters	Call Letters	Frequency Kc.	City Country
13.9+	W8XK	21540	Pittsburgh, Pa.	36.6+	PSK	8185	Rio de Janeiro, Braz
13.9+	GSH	21470	Daventry, England	37.3	CNR	8035	Rabat, Morocco
14.2+	LSN	21020	Buenos Aires, Argen.	37.5	HC2JSB	8000	Guayaquil, Ecuador
15.2+	IRV	19700	Rome, Italy	38.0+	JVR	7880	Kemikawa-Cho. Jap.
15.9+	PLE	18860	Bandoeng, Java	38.3	OA4AC	7820	Lima, Peru
16.5	LSY	18115	Buenos Aires, Argen.	38.4+	HBP	7790	Geneva, Switzerland
16.8+	GSG	17790	Daventry, England	40.5+	HJ3ABD	7402	Bogota, Colombia
16.8+	W3XAL	17780	Bound Brook, N. J.	40.5+	EA8AB	7403	Teneriffe, C. I.
16.8+	PHI	17775	Huizen, Holland	41.8	CR6AA	7177	Lobito, Angola,
16.8+	DJE	17760	Zeesen, Germany				Port West Africa
17.2+	J1AA?	17380	Kemikawa-Cho., Jap.	42.0	HJ4ABB	7138	Manizales, Col.
17.3+	W3XL	17300	Bound Brook, N. J.	43.8+	HAS	6840	Budapest, Hungary
19.4	PRADO	15440	Riobamba, Ecuador	44.0+	YNLF	6800	Managua, Nicaragua
19.5	W2XAD	15330	Schenectady, N. Y.	44.7+	JVT	6750	Nazaki, Japan
19.6+	CP7	15300	La Paz, Bolivia	44.7+	TIEP	6730	San Jose, Costa Rica
19.6+	CP5	15308	La Paz, Bolivia	45.0+	HC2RL	6668	Guayaquil, Ecuador
19.6+	W2XE	15270	New York, N. Y.	45.3	PRADO	6618	Riobamba, Ecuador
19.6+	FYA	15243	Pontoise, France	45.3+	RV72	6611	Moscow, U. S. S. R.
19.6+	PCJ	15220	Huizen, Holland	46.1	HJ5ABD	6504	Cali, Colombia
19.7	W8XK	15210	Pittsburgh, Pa.	46.5+	HJ1ABB	6447	Barranquilla, Col.
19.7	DJB	15200	Zeesen, Germany	46.6	W3XL	6425	Bound Brook, N. J.
19.8	GSF	15140	Daventry, England	47.5	HIZ	6315	San Domingo, D. R.
19.8	HVJ	15123	Vatican City	47.8	HJ3ABF	6275	Bogota, Colombia
19.9+	RKI	15040	Moscow, U. S. S. R.	47.8	H11A	6272	Santiago de Los
22.0	JYK	13610	Kemikawa-Cho. Jap.				Caballeros, D. R.
22.7+	ORP	13200	Ruyssede, Belg.	48.7	I2RO	6160	Rome, Italy
23.3	CNR	12830	Rabat, Morocco	48.7+	CJRO	6150	Winnipeg, Manitoba
24.8+	CTICT	12082	Lisbon, Portugal	48.7	VY3RC	6150	Caracas, Venezuela
25.1+	RNE	11924	Moscow, U. S. S. R.	48.7	VE9CL	6150	Winnipeg, Man.
25.2	FYA	11900	Pontoise, France	48.8+	W8XK	6140	Pittsburgh, Pa.
25.2	W8XK	11870	Pittsburgh, Pa.	48.9+	ZGE	6130	Kuala Lumpur,
25.2+	GSE	11860	Daventry, England				F. M. S.
25.3+	W2XE	11830	New York, N. Y.	48.9+	ZTJ	6122	Johannesburg, Africa
25.4	I2RO	11810	Rome, Italy	49.0+	W2XE	6120	New York, N. Y.
25.4	W1XAL	11790	Boston, Mass.	49.0+	YDA	6120	Bandoeng, Java
25.5	DJD	11760	Zeesen, Germany	49.0+	PK1WK	6116	Java
25.5	GSD	11750	Daventry, England	49.0+	VV2RC	6112	Caracas, Ven.
25.5+	PHI	11730	Huizen, Holland	49.0+	VE9HX	6110	Halifax, N. S.
25.6	FYA	11720	Pontoise, France	49.0+	VUC	6109	Calcutta, India
25.6	CJR X	11720	Winnipeg, Canada	49.1+	W3XAL	6100	Bound Brook, N. J.
26.0	XGR	11530	Manila, P. I.	49.1+	W9XF	6100	Chicago, Ill.
27.9+	JVM	10740	Shanghai, China	49.1+	VE9GW	6096	Bowmanville, Can.
28.1	CEC	10670	Nazaki, Jap.	49.3+	CP5	6080	La Paz, Bolivia
28.1+	JVN	10660	Santiago, Chile	49.3+	W9XAA	6080	Chicago, Ill.
28.3+	FVB	10578	Paris, France	49.3+	OER2	6072	Vienna, Austria
28.9+	LSX	10350	Buenos Aires, Argen.	49.3+	VE9CS	6070	Vancouver, B. C.
29.0+	ZFD	10330	Hamilton, Bermuda	49.4+	VV5RMO	6060	Maracaibo, Venez.
29.0+	ORK	10330	Ruyssede, Belgium	49.4+	VQ7LO	6060	Nairobi, Kenya, Afr.
30.0	KAZ	9990	Manila, P. I.	49.4+	W8XAL	6060	Cincinnati, Ohio
30.4	EAQ	9860	Madrid, Spain	49.4+	W3XAU	6060	Philadelphia, Pa.
30.4+	JYS	9840	Kemikawa Cho, Jap.	49.4+	OXY	6060	Skamlebaek, Den.
30.5+	IRM	9820	Rome, Italy	49.5	GSA1	6050	Daventry, England
30.6+	GCW	9790	Rugby, England	49.6+	HJ1ABG	6042	Barranquilla, Col.
31.2+	XETE	9600	Mexico City, Mexico	49.8	CQN	6024	Macao, Asia
31.2+	CT1AA	9600	Lisbon, Portugal	49.8	DJC	6020	Zeesen, Germany
31.2+	W3XAU	9590	Philadelphia, Pa.	49.8+	ZHI	6012	Singapore, Malaya
31.2+	VK2ME	9590	Sydney, Australia	49.8+	COC	6010	Havana, Cuba
31.3	HBL	9580	Geneva, Switzerland	49.8+	XEBT	6010	Mexico City, Mex.
31.3	VK3LR	9580	Lyndhurst, Victoria, Australia	49.9	VE9DN	6005	Montreal, Quebec
31.3	GSC	9575	Daventry, England	49.9	HIX	6000	San Domingo, D. R.
31.3+	W1XAZ	9570	Springfield, Mass.	49.9+	RV59	6000	Moscow, U. S. S. R.
31.3+	VUB	9565	Bombay, India	50.1	VV4RC	5984	Caracas, Venezuela
31.3+	DJA	9560	Zeesen, Germany	50.1	TXG	5984	El Liberal, Guatemala
31.4+	DJN	9540	Zeesen, Germany	50.2+	HVJ	5969	Vatican City
31.4+	LKJ1	9540	Jeloy, Norway	50.2+	HJ2ABA	5880	Tunja, Colombia
31.4+	W2XAF	9530	Schenectady, N. Y.	50.4	HJ4ABE	5860	Medellin, Colombia
31.5	VK3ME	9510	Melbourne, Australia	50.6+	HJ2ABC	5824	Cucuta, Colombia
31.5	GSB	9510	Daventry, England	51.4+	OA4AD	5820	Lima, Peru
31.5+	PRF5	9505	Rio de Janeiro, Br.	51.9+	TIX	5795	San Jose, Costa Rica
31.8	PLV	9415	Bandoeng, Java	52.9+	XQAJ	5660	Shanghai, China
				64.5+	HC2EP	4650	Guayaquil, Ecuador
				69.4	G6RX	4320	Rugby, England
				70.2	RV15	4273	Khabarovsk, Siberia
				73.0	HCJB	4107	Quito, Ecuador
				80.0	CTICT	3750	Lisbon, Portugal
				84.6+	CR7AA	3543	Lourenzo Marques, Mozambique

corded high honors!

KEE has been reported on 7710 kc. sending programs occasionally to Koko

Head and testing.

Many listeners report *not* hearing JVM lately and others report hearing JVN, 5-5:40

### LA VOZ DEL TROPICO (TIEP)

Here is a photograph of the "one-time" mystery station of Central America. The transmitter is shown at the right, with a hanging microphone and record-playing apparatus at the left. The station is at San Jose, Costa Rica, Central America

(Photo, courtesy, R. H. Tomlinson)

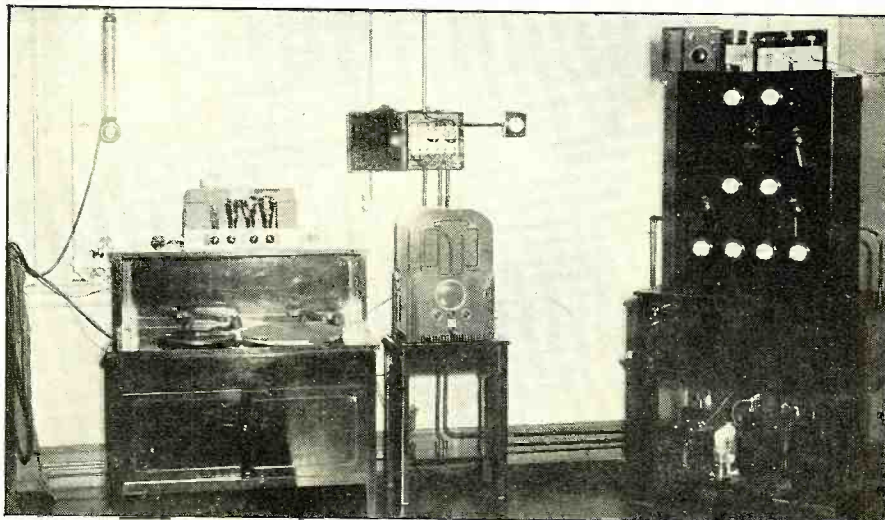

# WORLD DISTANCE CHART No. 5

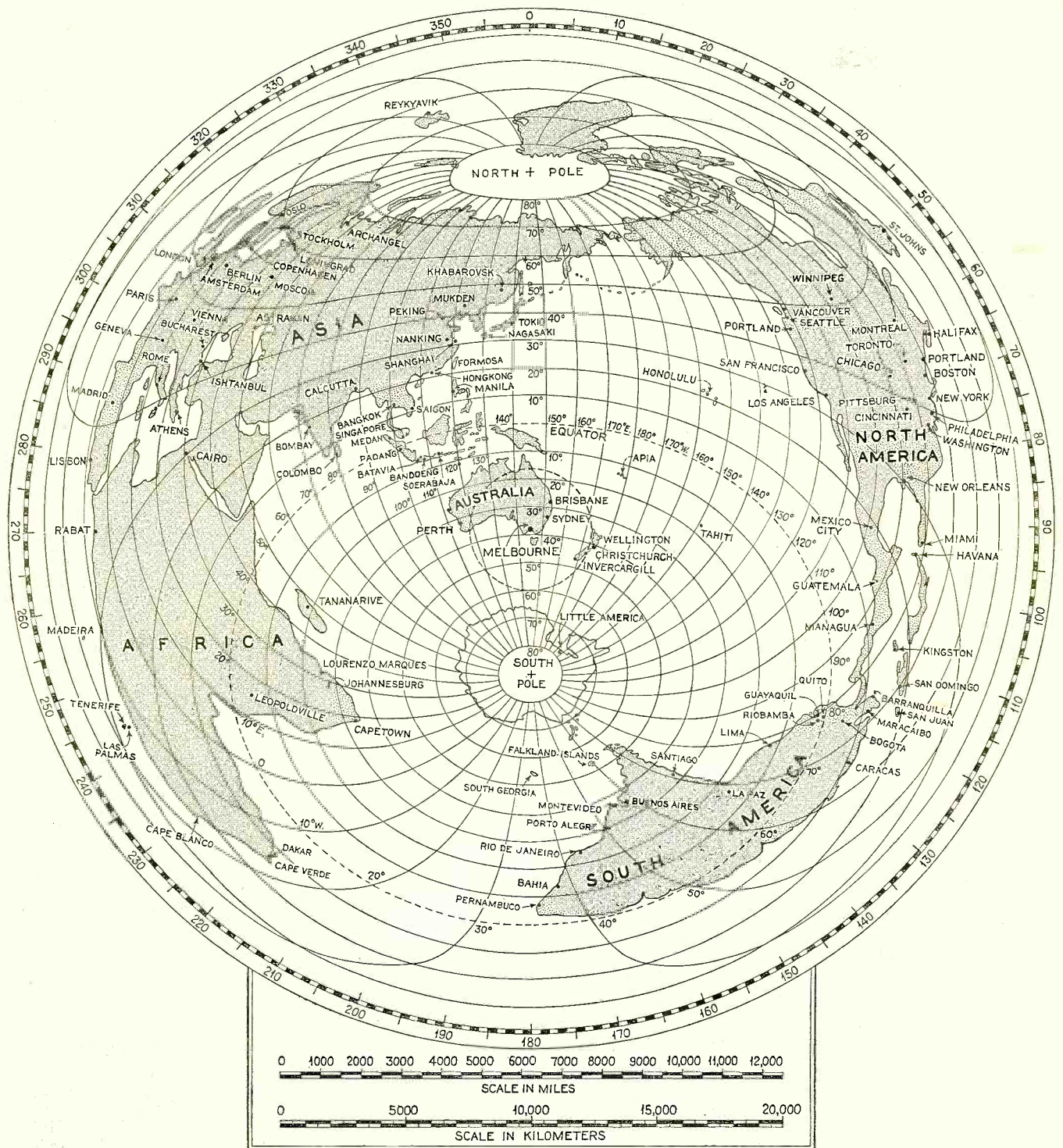

p.m., E.S.T. JVF is reported heard late afternoons and evenings on 15620 kc.

The new Dutch transmissions (reported last month as "PHI," 19.7 meters, 15220 kc.) coming from Huizen, Holland, carrying the same programs on the same schedule as PHI, on 25 meters, have been since found to be from station PCJ. In other words, the 19-meter station's call letters are PCJ and not PHI.

YNLS, reported as Nicaragua, on 44.3 meters, as heard around 10 p.m. (Editor's Note: Isn't this YNLF on 6692 kc.)

What was reported as a new station (in Almatica), heard contacting amateurs from 11 to 12 p.m., is believed to be TI2EP of

## THE WORLD DISTANCE MAP FOR SOUTHERN AUSTRALIA

Here is the fifth Radio News Azimuthal map, which is for the Southeastern part of Australia, centered on Melbourne. Measurements can accurately be made from any spot within the dotted circle to any other place on earth. Simply lay a ruler connecting any spot within this circle to any other location on the map and refer this distance to the scale in miles or kilometers; this will give the actual great-circle distance. This is the fifth exclusive Radio News Distance Chart published in this series

San Jose, Costa Rica. Almatica seems to be another name for the same place.

Radio D.U.S.A., reported as Lima, Peru, on 51 meters. (Whatever that means.)

A new Japanese station is reported on 42 meters and another one on 15 meters.

YDA reported heard on 49.02 meters, 6120 kc.

KNRA reported on 33 meters or 8820 kc. RNE sends news on Sunday, at 9:45 a.m., E.S.T.

LSY reported on 18.1 megacycles. EAQ, Madrid, Spain, generally reported very weak lately.

PEF, 49.02 meters, reported as Batavia, (Continued on page 448)



## SHORT-WAVE PAGE

THE collecting of verifications from short-wave broadcast stations has gone far beyond a hobby. Through my contacts with fans many important facts about collecting "veries" have been brought to my attention. So strenuously have some collectors gone at their search that methods which are not always ethical have been adopted by some "fans." When this happens the hobby does more harm than good, as one instance (which I know of personally) will show.

TWO short-wave fans (we will call them Brown and Smith), hear a certain station. Brown writes for a "veri," so does Smith. The former is fortunate in having a typewriter, or, if not, writes a more legible hand than the latter. Brown receives his veri. Smith does not, but continues to wait, endlessly, hopelessly. His veri never comes. Brown may flout his veri under Smith's nose. As a result, hard feelings spring up between these two, who had once been friends because of a common interest in short waves.

Methods, not always sportsmanlike, have been adopted by veri collectors. Here are a few that I know of. One fan typed his own veri on a card. It may seem impossible, but this is how he did it: He wrote a letter to the station asking them to sign and mail an enclosed card which had a stamp of the country already attached. On the card he himself had written "Your reception verified," or words to that effect. This scheme worked in a number of instances. And now we come to the fan who *hears* of a new station being heard by someone else. He writes to the station, inquiring for information as to its time on the air. When the answer comes he calls it a veri!

We recently saw a very interesting article on "How *not* to write for a verification." According to the author of the article, "It won't be a bit of use sending in a report like this to a station: 'Last Wednesday I heard a woman singing a dance tune which I know quite well, but I can't remember the name of. It wasn't very loud but I am sure it was your station. I have forgotten the exact time, but it must have been after 1:00 a.m. because our cat wanted to go out. I have often wanted to hear your station, but have never done so before. I await your reply. . . . Yours truthfully,' Hiam A. Lyre. Reports such as these will not and should not be acknowledged by radio stations.

As a persistent veri collector, I have risen early and even stayed up all night to log an elusive catch. But now I have gone in for something more concrete than a card or letter. I now make a disc recording of each and every program that I hear from some far-away station. Up to the present time I have in my record collection programs from every continent. These include OPM, ORK, England, Germany, France, Portugal, India, Spain, Japan, Switzerland and South America. The recorder that I use is home-made and is at all times attached to my receiver. All that is required is to throw a switch, start the motor, and I am ready to cut a record. The recorder is hooked up to my superheterodyne receiver (which has a.v.c.). The signal is taken off the 2nd detector tube, then through a 200-ohm transformer to the recording outfit. The records I record on are ungrooved acetate.

When a doubter says, "Did you ever hear Japan?" I merely go over to my record cabinet and let him hear the Nipponese for himself.

We will now take a typical day of good reception conditions. 3:50 a.m. and VK3LR, Melbourne, Australia (31.32 meters), is heard. The next station logged is W3XL, Bound Brook, N. J., sending a special program (on about 17 meters). Then we will go Oriental (on 44.44 meters) and we literally run into JVT, Tokio, Japan. From 4:03 a. m. to 4:36 a.m. we hear them with an R-6 signal. First there will be a woman talking and then a man takes up the cudgels where she left off. At 5 a.m., VK3ME, 31.55 meters Melbourne, Australia, comes on the air with "Hello, this is VK3ME," etc.

We now dial to the 16-meter band and see what is on. As we start going up the band we run afoul a very strong carrier. HVJ (19.84 meters), Vatican City, is heard. From the low bands we drift to the 49-meter band. (Yes, we do some hopping around.) On 49.02 meters we will nurse in a very weak carrier, until by 5:23 a.m. a man's voice is audible. We will hold this signal until 6:12 a.m., making careful notations of selections played, as it is a new station on the air. It has been identified as a Java station, on the air daily from 5:30 to 11:30 a.m. and gives announcements in Dutch and then in English. The announcement is "Nirom." The program consists of English and American dance records. Reports of reception should be addressed to A. H. K. Mulder, Broadcast

Leader, Dutch East Indies Broadcast Company, Bodjong 140, Semarang, Java.

Now we will go back to the dials and the ether waves. Ah, DAF (24.02 meters), Norden, Germany, has a strong signal, and then the operator in Germany says, "Please hold on—I will bring you Berlin in a moment. Wait a minute! Berlin is busy calling Manila." That was enough. Manila will be our next port of call. On about 17 meters, a powerful carrier is heard. "Hello, Tokyo. This is KAY, Manila, calling you." After a few minutes of trying to contact them, KAY sends a parting shot, "This is KAY calling you. Hello, Tokio. JVQ on 7470 meters." JVQ (40.1 meters) is our next move in this interesting game of chasing the frequencies over the ether chessboard. Faint music is audible on that wavelength, but contact talk is blanketed by rising static so prevalent at this time of the morning on this band.

We retire for a few hours, and start in again at about 3 p.m. England (on 31.3 meters) has a very strong signal. A golden-voiced English songbird sings our own "I Saw Stars" in typical English style, but we like the banjo selection that follows much better. ORK (29.04 meters), Belgium, fades in and out with a musical selection that is too much of a tax on our ears to identify. WNC (15 meters) is talking to some one, so we leave Florida and go to Ocean Gate, New Jersey. There we find WOO (63.1 meters) is "heloing" the *Europa*, first calling the ship by name, after which the operator starts to count in German, followed by "Hello, DOIA. How are you getting me?" We scan the dials and on approximately 34 meters the operator on board the *Europa* is calling "Hello, New York. How are you getting me?" Mentally we answer fine. "This is terrible," continues the *Europa*. "You are fading out completely." We will leave these two to their worries and see what the foreign locals are up to. France (on 25.4 meters) is good; England (on 31.5 and 25.5 meters) is excellent.

From that time until 7 p.m. the following stations are logged: HPF (20.6 meters), Panama, signing off with WNC; HBJ (20 meters), Bogota, calling Hialeah; CM6XS (20-meter amateur) calling CQ; Daventry, now an R9 (on 31.5 meters, as the 25-meter transmission has faded out); GBC (34.5 meters), Rugby, England, arranging for traffic tests with New York and also indulging in "kidding" a Miss X; PRF5 (31.5 meters), Rio de Janeiro, with a political speech.

South Americans come and go and so except for DJC (49.83 meters), who "suffers" from a severe attack of heterodyning from XEBT, the evening will be fairly profitable. COC (49.9 meters), Havana, Cuba, "plays ball" on the 49-meter band and finally leaves about 6 p.m. On about 53 meters an unknown Spanish-speaking station chimes the hours by means of a diminutive "Big Ben" and then leaves the air.

Hats off to HI1A! English announcements have proven very helpful to all listeners, enabling them to identify this station. This fairly low-powered station comes over beautifully and when the announcer says, "Ladies and gents, you are listening to H-I-1-A," etc., we are more delighted to hear our own tongue spoken than anything else. Why do not a few more of these stations to the south of us give us *at least one hourly announcement in English?* H-I-1-R requested reports of reception and offered a gift to anyone whose report proved accurate.

We were surprised and amused when we received a letter from the Radio Corporation of America, 66 Broad Street, New  
(Continued on page 443)



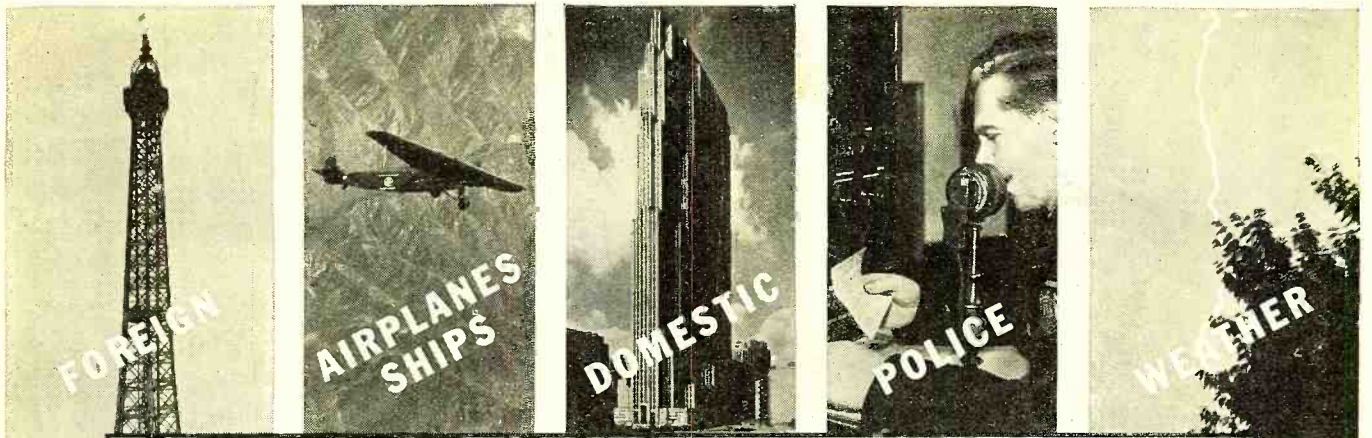

## “MAGIC BRAIN” scoops radio world, every thrill in all-wave easily yours

Yes... the whole world of radio is yours... and only RCA Victor can give you all these services as standard equipment, including the famous “X” band\*—all with new tuning ease and accuracy... more stations far and near... Higher Fidelity tone.

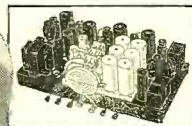
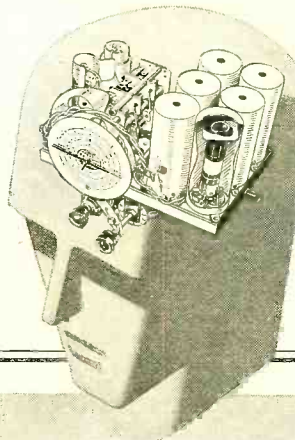

What RCA Victor's “Magic Brain” Does

Inside RCA Victor all-wave sets is an uncanny governing unit—shown here as part of the regular circuit and tubes. Human in its thinking, we compare it to the human brain. You choose the broadcast—from no matter where in the whole world. Then, watchman-like, it keeps out undesired radio signals. It concentrates on that one and makes it four times stronger. Each tone has higher fidelity... in a quality reception heretofore unequalled.

**S**NUG in your own living room this winter listen to the world at work and play! Hear stirring events in every land... travel with intrepid explorers... enjoy the opera in Italy, a symphony in South America, a speech from Sydney, Australia!

Today... with this new RCA Victor “Magic Brain” directing and selecting the program you want... all-wave radio has at last reached a climax. This sensational RCA Victor development (which has swept across the radio world like a new comet) makes possible far greater ease of tuning... far greater selection of stations. Clear, clean super-reception results! The kind you've wanted—but never heard!

If you could but hear what the “Magic Brain” does for tone, too! It lifts up, elevates, in magician-fashion each note... from tiniest treble to deepest bass. You'll thrill to the core as each foreign or domestic program sweeps in—utterly true, satisfyingly rich. It's true

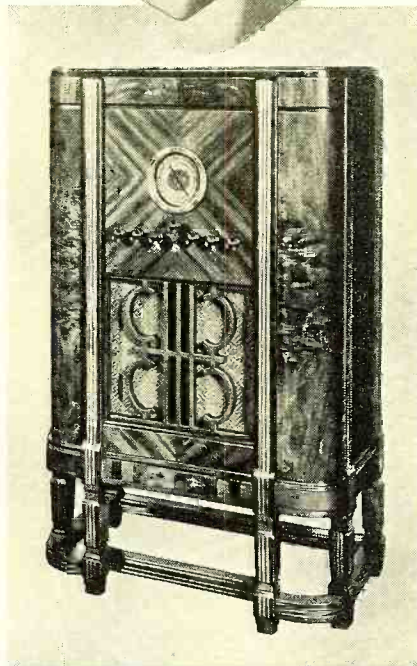

**EVERY WORLD RADIO DELIGHT YOURS**  
MODEL 262—5-band “Magic Brain” Superheterodyne. Tone Control, automatic volume control... all short and standard wave broadcasts. De luxe cabinet. **\$149.50**

Higher Fidelity tone... the final result of 35 years of Victor experience in sound recording and reproducing delivered to you! Added to all this is the famous RCA Victor “X” band... a separate wave band bringing you the new government weather service... the reports aviators hear as they fly!

All this achievement is housed in cabinets of rare delight. They are exquisite, modern. Truly it can be said that never has radio reception and radio enjoyment reached so great a height as in the new RCA Victor “Magic Brain” sets. You owe it to your ears, your eyes and your pleasure to own one. Now at your nearest RCA Victor dealer's... at prices you can afford!

**A RADIO AND A PRICE FOR EVERYONE!**  
RCA Victor instruments priced from **\$18.75** to **\$375.00** including Standard Receivers, Auto Radios, Air-Cell Battery Radios and Radio-Phonographs. All RCA Victor instruments equipped with RCA Micro-Sensitive Radio Tubes. All prices F. O. B. Camden, N. J., subject to change without notice. Any short-wave radio performs better with an RCA World-Wide Antenna.  
\*The “X” band is in all sets of 8 tubes or more.



# RCA VICTOR

# 18-50 and 200-550 Meter SKIP-BAND "SUPERHET"

This inexpensive 6-tube receiver provides "8-tube" results. It is available in kit form for the home constructor

Robert Hertzberg\*

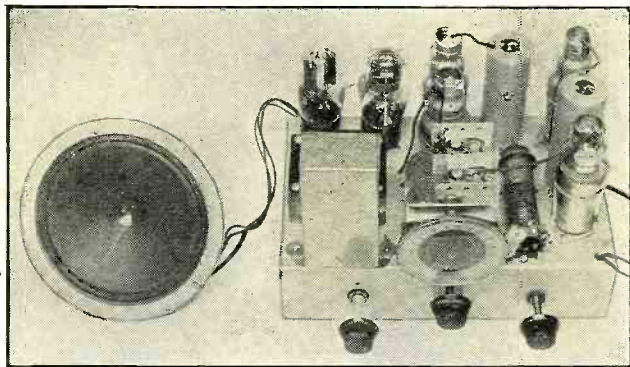

THE FINISHED RECEIVER

The layout is compact—but not so much so as to make parts inaccessible for wiring. The construction job is one which is well within the ability of the average experimenter

IN their efforts to satisfy the ever-increasing demand for new all-wave and short-wave receivers, radio designers, manufacturers and merchants seem to have lost sight of the fact that many people still want to build radio sets, either for themselves or for resale as custom-built instruments for installation in cabinets of the ultimate purchaser's choice.

There was a noticeable drop in interest in home receiver construction between the spring of 1932 and the summer of 1933, but the restless experimenters, constructors and servicemen who read of the two-in-one and three-in-one multipurpose combination tubes are feeling the building itch once more, and there certainly is no more rabid "bug" than the radio variety!

This little receiver, measuring 10 1/4 inches wide by 6 1/2 inches deep by 7 1/4 inches high, has been brought out to meet this market demand. Known as the "Skip-Band" set, it is a 6-tube, a.c.-operated superheterodyne using the latest type tubes and covering the 18-50 meter domestic and foreign short-wave stations in addition to the regular 200-

550 meter broadcast spectrum. It is supplied in complete kit form, including a drilled steel chassis ready for convenient assembly. The only tools required for the job are pliers, a screw-driver and a soldering iron.

The six tubes really do the work of eight, as two of them are dual-purpose tubes. The circuit, as shown in the wiring diagram, Figure 1, is easy to follow. The 6A7 type tube, V1, acts as the frequency converter, supplying the local oscillator frequency and at the same time mixing it with the signal frequency to provide the desired intermediate frequency, in this case 465 kc. A two-gang condenser (C1-C2) tunes the detector and oscillator circuits. The four-pole, double-throw switch (WBS) is the wave-changing switch and is controlled from the front of the set. The coils marked H are for the broadcast band and those marked L are for the short-wave band.

The 465 kc. output of V1 works into the 465-kc. i.f. transformer and the tube V2, a type 6D6, which together constitute the first intermediate-frequency amplifier stage. This in turn feeds into a second i.f. stage, also employing the type 6D6 tube.

The amplified 465 kc. signal is fed from the untuned transformer, I.F.3. into tube V4, which is a type 75 duplex diode high-mu triode tube. This interesting tube combines the functions of second detector, audio amplifier and automatic volume control. All this sounds complicated, but it really isn't. The two diode plates are connected together, and with the cathode act as a simple half-wave rectifier. The rectified signal is picked off the volume control, R1, then sent right back into the same tube and amplified at audio frequency by the triode (Continued on page 443)

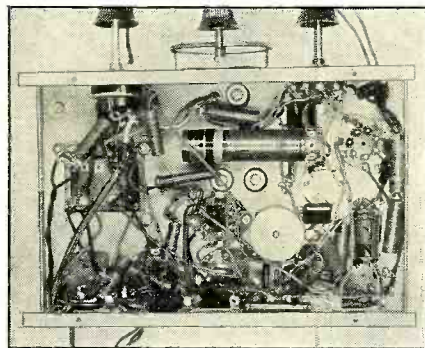

\* Formerly Editor Short Wave Radio.

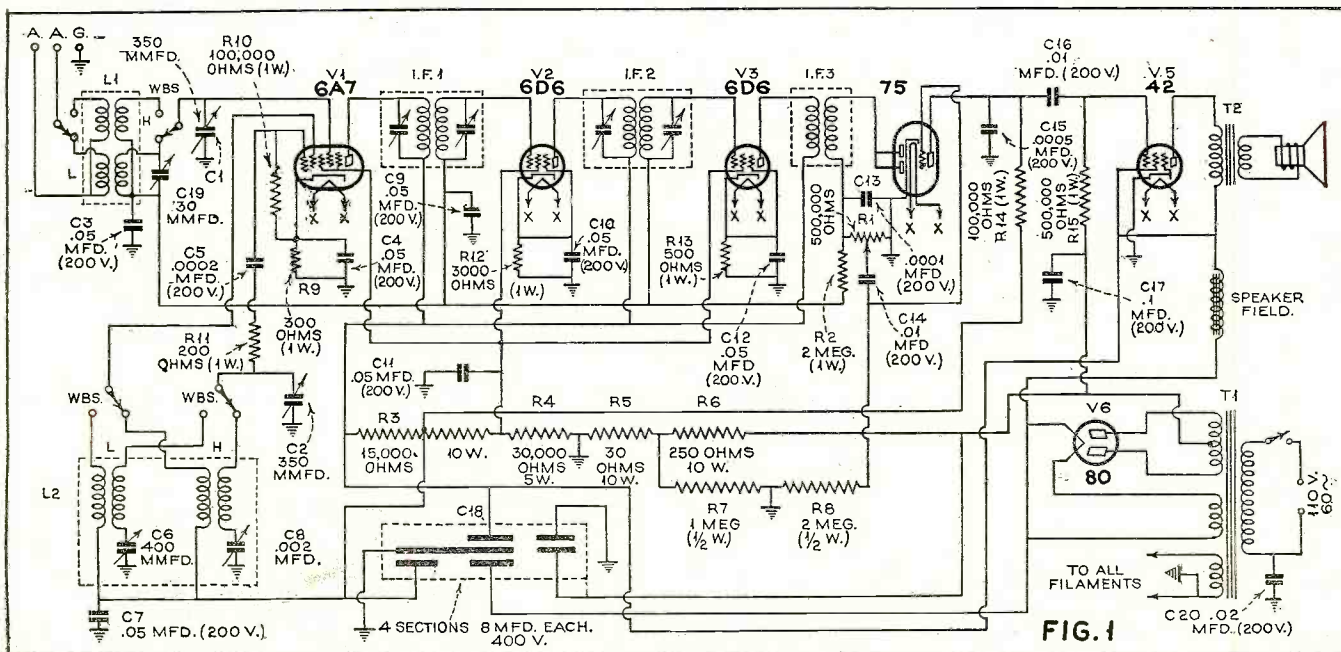

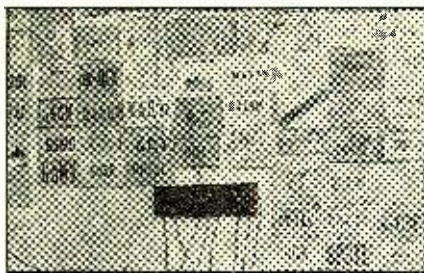

A FAMOUS RUSSIAN AMATEUR  
At the left is the amateur transmitter station with its owner, A. V. Vesenin, a noted actor of the Maly Theatre, Moscow. The right-hand illustration shows some of his verification cards received from amateurs all over the world who have heard his signals.

# THE "HAM" SHACK

CQ CQ CQ

THE greatest curse of the three major amateur telephone bands is "over-modulation." It is responsible, in a large measure, not only for the interference on these bands but also is one of the major causes of interference to broadcast reception. There is no excuse for over-modulation; there is no reason why it should exist! Yet, despite all the ways of determining when a transmitter is functioning according to Hoyle, it still persists.

Just why a large number of 'phone station operators break over on their side bands (and this goes for old-timers as well as the newer-comers) seems to be a mystery. The most plausible answer is that the psychological reaction to trying to work a distant station causes operators to shout into the microphone without regard for other stations trying to carry-on contacts on the band. Stations with high power are as frequent offenders as lower-powered stations. Care in designing and operating the amateur 'phone transmitter and the use of some means of checking the quality and modulation percentage should be considered.

MODULATION around 100 percent does not accomplish anything but harm. In addition to its interfering qualities, it causes distortion to no end with the result that fewer stations are "worked." No one likes to talk to a station having poor quality! It might be said that one seldom hears over-modulation on the regular broadcasting channels. The powerful broadcasters, with their twenty and fifty kilowatts of output, seldom come anywhere near the 100 percent mark. High power is used to provide a heavy carrier for the suppression of static and other disturbances, but the modulation superimposed on these carriers usually does not exceed 50 or 60 percent.

While amateurs have come to regard this practice as a waste of energy, I believe it would be a good rule if they were to limit their peak modulation to approximately 80 percent. The effectiveness of such a modulated signal would not be far inferior to maximum, but it would tend to reduce QRM. Not all amateurs are fortunate enough to be able to equip their stations with oscilloscopes, although the prices of these instruments have been more nearly suited to the amateur pocketbook within the last year. But there is the much-disregarded and reasonably accurate method of calculating the percentage from the antenna current swing on modulation peaks. The rule I use is a simple one: when the antenna current increases 22 percent of its normal carrier value, the available audio power is doubling the wattage output, or modulating about 100 percent. If this rule were observed by more stations, there would be less side-band crackling heard throughout the various bands.

Another method of determining percentage of modulation is to use a neon tube of the type used to indicate "peak resonance" in broadcast receivers. These neon bulbs are about 3 1/2 inches long and are made with an automobile lamp with a double-contact base. Each of the terminals connects to a wire inside the neon-filled tube; a long one extending almost to the tip of the tube and a short one that barely extends beyond the base. By connecting one of these indicators in a wavemeter circuit, an improvised modulation meter may be constructed for less than a dollar. It may be calibrated with an oscilloscope or standard modulation meter.

The method of calibrating is simple. The wavemeter with its neon tube is tuned to resonance in the vicinity of the modulated amplifier tank coil, and it is then moved away from the radio-frequency field until about 1/4 inch of the gas nearest the tip is "ionized." This point may be marked on the neon bulb with china marking ink so that it is possible to again place the meter at the proper relative position to the tank coil. Then modulation is applied, and at the same time the percentage of modulation is noted on either an oscilloscope or modulation meter which may be borrowed from some friendly amateur who is equipped with such an instrument. A pure tone or sine wave should be used to

modulate the carrier. The gain is then set until it reaches the 100-percent mark on the calibrating instrument. The ionization of the neon gas will appear to move up and down in the bulb in the same manner it indicates resonance when used in a receiving circuit. When the 100-percent peak is reached on the oscilloscope or modulation meter, the ionization will take place in more than three-quarters of the tube. It will vary with different tubes. This point should be marked on the glass the same way as the zero joint. By the same manner, 50 percent modulation or other percentage marks may be indicated on the tube, and one has an inexpensive means of checking modulation percentage. It is not always necessary to connect the neon tube in a wavemeter circuit. While this makes the instrument entirely portable, the same results may be accomplished by finding a point on the antenna or feeder wires where the carrier will just cause the tip of the tube to become ionized. In this case only the base terminal connecting to the long internal wire is used. It may be permanently connected to the antenna and calibrated against a standard instrument.

Of course another highly accurate method of determining modulation percentage is through the use of a regular modulation indicator. These instruments are in the category of oscilloscopes. They are more costly than the methods just described.

Last month we described the construction of a "universal" speech amplifier that may be used with several types of modulators capable of giving 100 watts of audio power. The unit may be used to drive three or four 845 type tubes in Class A modulation, a pair of 210's, 801's, RK18's, 800's, 830's or 830-B's in Class B. The -45 type tubes in the push-pull stage may be replaced by a pair of 2A3's and the unit used to drive a pair of 203-A's in Class B. While the -45 will drive a pair of 830-B's in Class B, the 2A3's as drivers are better suited for this more powerful of the new intermediate power tubes.

An excellent companion piece to go with the "universal" modulator is illustrated herewith. It is mounted on a base identical in size to that used for the driver stages and employs a pair of carbon plate 210 type tubes having a plate dissipation of 20 watts. These tubes are the ideal type for the small power Class B modulator. They are not extremely costly, require a reasonably small amount of voltage and deliver an audio output power of the order of 50 to 60 watts. This is sufficient to modulate a 100- to 120-watt input on the final amplifier stage 100 percent.

The base dimensions are 8 by 17 inches. Most of the apparatus is mounted above the base as a safety measure, because of the danger of flashovers with high audio voltages. The layout follows the schematic wiring diagram. The input transformer de-

(Continued on page 447)

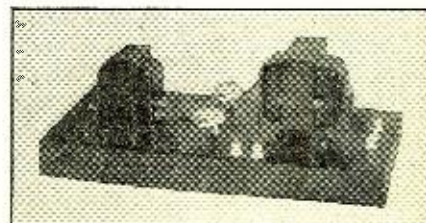
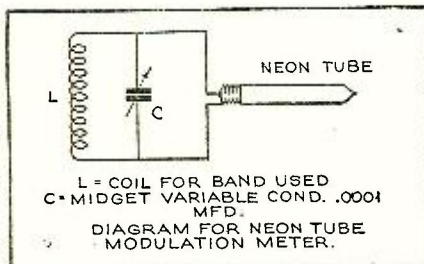
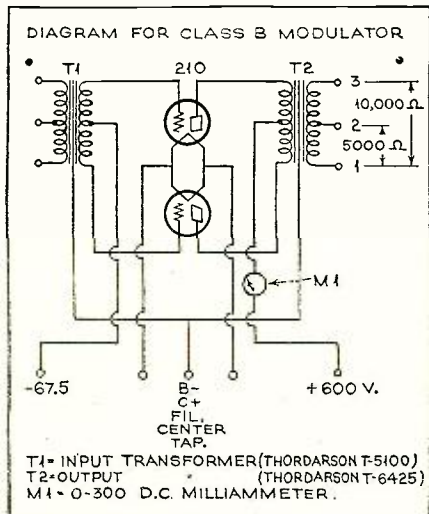

# EDUCATION

## "MAKING

### The Radio Operator

Getting the training necessary to secure and hold the position you want in radio. This month's installment covers the general problems of operators and students who have written to the Editor for advice on the subject



**THE BROADCAST OPERATOR**

*Here is a student broadcast operator practising on a broadcast control panel in the students' control room at R. C. A. Institutes*

**By Zeh Bouck**

*Part Two*

**T**HE number of individuals engaged in any one of the several broad divisions of the radio field seems to vary indirectly with the degree of training involved. Similarly, the average amount of compensation maintains a reversed ratio with the aggregate employed in any specific category of radio jobs. In the first article of this series it was demonstrated that, exclusive of factory employees, there were probably more people making a living in the service field than in any other branch of radio work. This is because it is one of the easiest of the various radio jobs for which one may train. Other contributing considerations are the facts that the initial financial outlay is relatively low, and the field is practically unlimited as far as individual endeavor and enterprise are concerned.

The radio operator comes next. The average operator must be well-versed in the fundamentals of electricity and radio, must also know his transmitters, and in the majority of instances has devoted much time to gaining proficiency with the Code. Practically every operator is an expert serviceman—if he wishes to be—while the reverse is not necessarily true. As a matter of fact many operators, for various reasons, turn to the service game, and almost invariably make a success of it. The man trained as an operator has the advantage of being capable of holding down either job, and therefore stands a better chance of employment.

The pay for operators varies considerably. On ship board he receives from \$60.00 to \$130.00 per month—depending upon his rank and type of vessel—plus board, lodging, transportation and laundry. Shore stations pay from \$35.00 to \$50.00 a week—and sometimes more, depending upon the tenure of service. Broadcast operators receive about the same or better wages.

#### MARINE INSTRUCTION

*Radio operators must become skilled in the use of standard types of marine receivers for use on ships in code reception.*

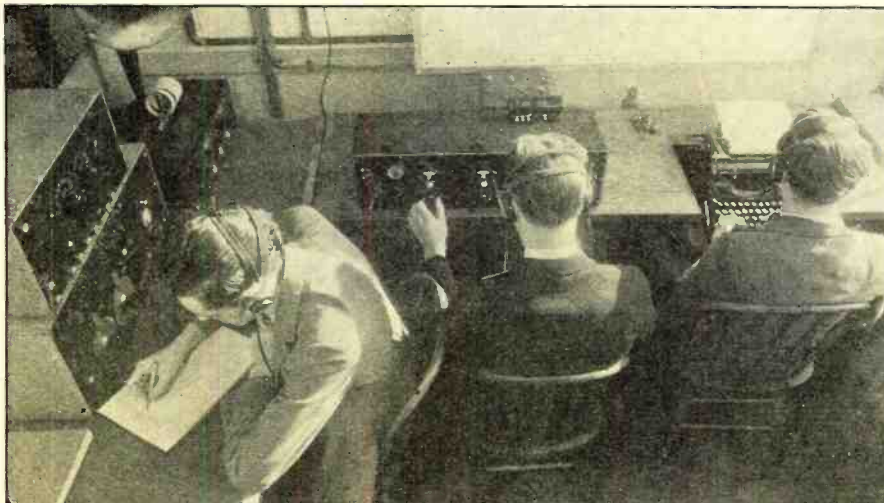

Aviation radio now presents interesting possibilities and monetary returns, governed by the hazards involved and geographical location. Ground station operators receive slightly higher salaries than those paid shore-station operators—sometimes a considerable bit more when the operator is stationed away from his home for any length of time. With the exception of Pan American, most plane-to-ground communication is carried on by 'phone, the pilots doubling as operators. However, Pan American also employs code operators who are experts of the first water.

In addition to the conventional operating jobs there exist other miscellaneous positions, in experimental and development work, radio beacons, government service, etc., which are open only to licensed operators, and which return excellent wages.

There will probably always be situations for the more-expert and better-trained operators. Also, operators are continually deserting the ranks, through advancement to bigger jobs, etc.

If inclination—or better yet, downright interest—leads you to believe that operating offers a career, or a stepping stone toward one, it will be advantageous first to consider the various operating jobs in the light of personal preference and the time and money you can devote to preparing yourself to fit them.

Ship operating has always held its appeal to the imagination. The ship operator ranks with the ship officers. He has no expenses, and should be able to save a good bit of money if he can resist—to a reasonable extent—the multitudinous temptations of foreign ports. However, family connections, in many instances, limit one's choice to situations on shore. The training required for this latter type of job is often more exacting than that demanded by mobile positions, as many shore stations require land-line Morse ability in addition to International. Broadcast operating may be the choice of those who find glamor in the proximity of stars and in studio associations. Also, many radiotelephone operating situations require no knowledge of code. Aircraft

# for A LIVING IN RADIO"

radio is probably the most alluring from an adventurous and romantic standpoint.

Aside from amateur operators' licenses, there are seven various grades and types of licenses now being issued by the federal government—Commercial Extra First Class, Radiotelegraph Operators First Class, Radiotelegraph Operator Second Class, Radiotelegraph Operator Third Class, Radiotelephone Operator First Class, Radiotelephone Operator Second Class and Radiotelephone Operator Third Class. No code examination is required for the latter three licenses.

As the first step toward securing a license of any grade, it is recommended that the student send sixty cents to the Superintendent of Documents, Government Printing Office, Washington, D. C., for the "International Radiotelegraph Conference" (30c) and the "Federal Radio Commission Rules and Regulations" (30c). The books contain a complete exposition of radio law—knowledge of which is required for all types of licenses—and describe the requirements for, and the service limitations imposed upon, the various grades of operators.

Aside from detailed familiarity with the radio rules, regulations and international abbreviations, the applicant for a license is examined on general radio theory, transmitters and receivers—the required knowledge becoming more comprehensive with the high license grades. Similarly the speed at which he must be able to send and receive Code is greater for the superior licenses.

There are three methods of training for an operator's ticket and a job—self-training at home, by correspondence and in residence schools. It is possible to train one's self to become an operator. Many commercial operators have done so—usually being graduated from the amateur class. In self-training, it is almost essential that the would-be professional operator own his own amateur station. As a matter of fact it will be of inestimable value regardless of the manner in which the student trains. In any event, a short-wave receiver should be on hand. Many self-trained operators find it desirable to solidify their knowledge by attendance to a residence school, or by reviewing a correspondence course. In any event, it is desirable to reverse this process and supplement correspondence training with intensive independent study and amateur operating. The correspondence courses provide more of a general radio background—which is always desirable

—rather than preparing the student specifically for a telegraph operating job. Some attention is usually given to code—memorization, traffic handling, etc. The Radio and Television Institute devotes a generous section of their course to short-wave radio and considerable material is included which is of value to the student operator. The National Radio Institute provides a supplementary course for code operators at an additional fee. The International Correspondence Schools have four radio courses, one of which has been prepared especially for prospective operators. Training at a residence school is probably the most effective method of becoming a wireless operator. Here the student gains familiarity with the equipment he hopes eventually to operate, both at first hand and in adequate texts. He enjoys the psychological acceleration of association with other students having similar aims and solving identical problems. His code work is supervised by experts and his transmitting style developed. He is trained directly for a Second Grade Ticket, and both the Code and technical examinations at the schools are a bit

#### LEARNING THE CODE

*Here is a group of students learning to transmit and receive "code" on buzzer-practice sets at the New York Y. M. C. A. school.*

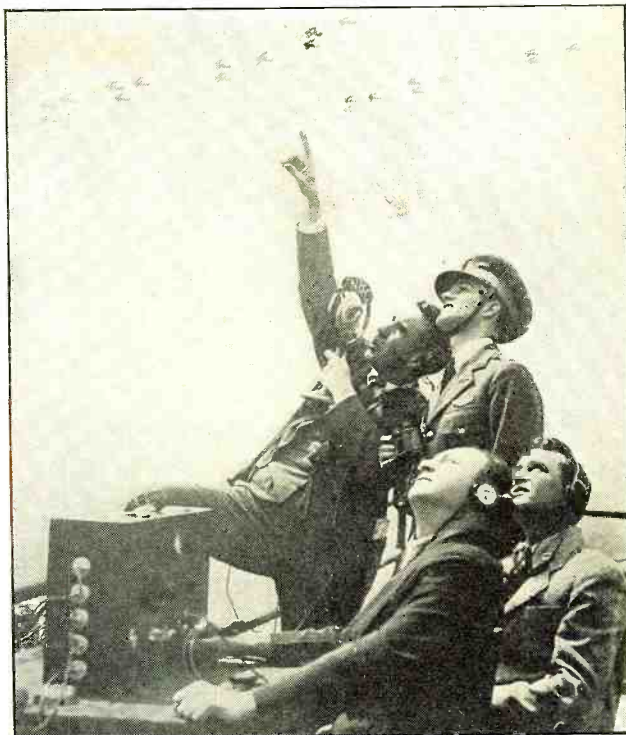

#### FOR "FIELD" OPERATING

*Before and during the broadcast of special events, the operators must set up and monitor portable lines to the station.*

stiffer than those given by the radio inspector. A student graduated from a residence school seldom fails on the government tests. Due to intensive training, the student is prepared for his license at the end of six months—the regular time required at most schools such as the RCA Institute, the Dodge Institute and the New York Y.M.C.A. This is for daytime attendance averaging from six to eight hours a day, about half of which time is devoted to code practice. The evening school at the Y.M.C.A. takes one year.

The average cost of residence courses is under \$120.00.

The rapidity with which code proficiency can be obtained depends upon the natural ability of the student and the time he is able to devote to practice. I am indebted to Walter H. Candler, of (Continued on page 447)

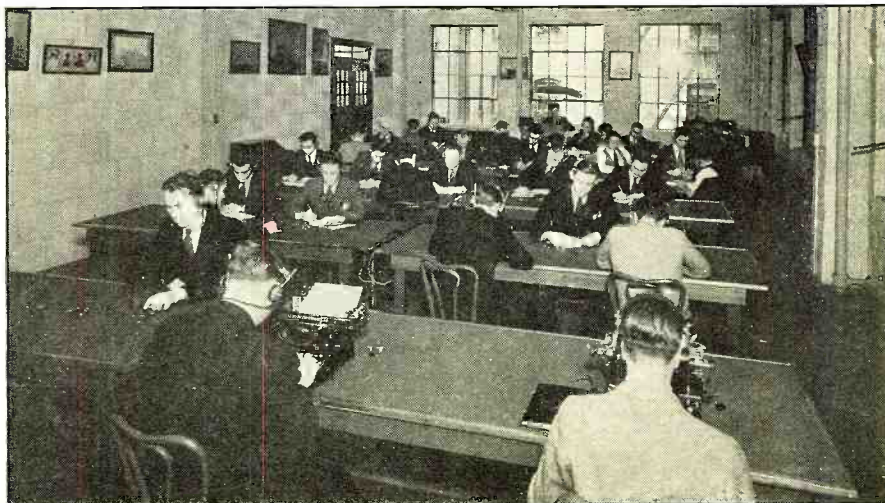



*Short-Wave*  
**MARINE  
RADIO**

**Frederick Siemens**

**O**NE of the most elaborate radio relay installations ever placed aboard a yacht was made for the "Norsaga," the ship especially chartered to "cover" the America's Cup

races last fall. The yacht was transformed into a floating radio office from which reports were flashed by code to newspapers throughout the world and by words to the NBC New York studios

**SHORT-WAVE SHIP RELAY**

*The Main Cabin aboard the motor yacht "Norsaga," used as short-wave receiving station during the cup races. In circle: 150-watt short-wave transmitters installed in the after cabin for relaying, by short waves, to the regular broadcast stations*

for relaying throughout the nation.

Antennas were stretched fore and aft on the 110-foot ship to permit the simultaneous operation of three transmitters and four receivers. The after cabin contained two short-wave, 150-watt, radiotelegraph transmitters. An official of the operating company stated that probably no marine transmitters ever cleared traffic as quickly as these units, for they were connected to automatic tape-senders capable of operating speeds up to 200 words-a-minute. The transmitters used master oscillators so that the motion of the yacht would not alter the frequency on which operation was being accomplished.

The NBC employed a short-wave transmitter and short-wave and ultra-short-wave receivers on board. The 50-watt transmitter sent the announcers' comments to a mobile relaying unit on shore. The ultra-short-wave receiver was used to receive reports from the Committee Boat "Wilhelmina." When the "Wilhelmina" was too far at sea for direct reception of ultra-short-wave signals on shore, the impulses were automatically relayed by the "Norsaga."

MIGHTY OAKS FROM  
*Little*  
**"ACORNS"**  
*Grow*

**A. Fenderson**

**I**N the March, 1934 issue of RADIO NEWS Mr. John Borst first described a new short-wave tube, invented by B. J. Thompson and G. M. Rose, Jr.; a "Lilliput" tube no bigger than a button on your coat. Due to the tremendous interest shown in this tube for the ultra-short-wave field, a new model of this radio tube of miniature size has been placed on the market for the especial purpose of aiding amateurs and experimenters in micro-wave tests. The tiny valve, recently introduced by RCA-Radiotron, now has been officially named the "Acorn Tube" due to its resemblance to an acorn in size and shape.

Emphasis was laid by the manufacturer on the fact that the tiny tube has been devised exclusively for amateur and experimental use and that it is in no way to be considered a substitute for use in standard types of receivers! The application of the new tube depends on the uses found for it by the purchaser after studying its technical

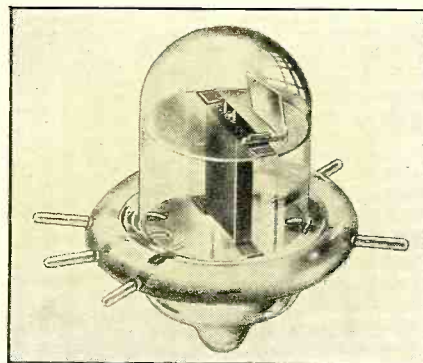
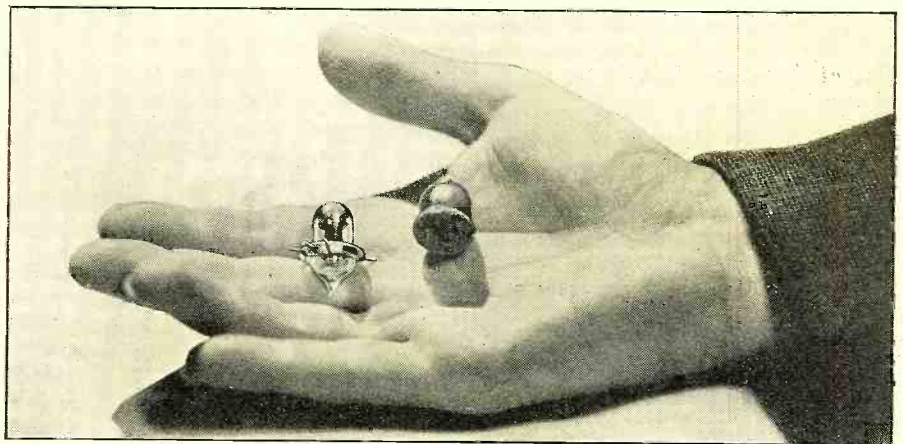

**A LILLIPUT TUBE, INDEED!**

*Comparison of the new "acorn" tube with a real acorn, lying in a man's hand. At left: A more detailed view of the tiny tube, twice enlarged*

work which led up to the practicable application of short-waves. Now, it is felt that much of the future of the ultra-high frequencies depends on the groundwork laid out by these experimenters.

The 955, as the tube has been designated, is a heater-cathode triode adaptable as an amplifier, detector or oscillator at frequencies up to 600 megacycles — approximately 1/2-meter in wavelength. This valve is said to be the only true triode capable of operating on ultra-short-waves and is therefore considered (*Continued on page 449*)

characteristics. It is not planned to immediately market any receiver or transmitter to accommodate the tube.

Amateurs have been accorded considerable praise for their constructive

# The New INDUCTOR MICROPHONE

Sam Kaufman

A NEW microphone which can advantageously be used for remote control broadcasting has been designed by the RCA engineers. The unit, known as the Type 50-A inductor microphone, was especially designed for broadcasts from points outside the studio. Constructed for either indoor or outdoor use, the microphone is insensitive to wind and unaffected by weather.

Although recognizing the technical superiority of the velocity microphone, the engineers felt that the ribbon device was inevitably more critical as to placement. Although the details of microphone placement can carefully be determined in studios, it is quite impractical to make such directional observations at remote control pick-up points. Thus, it was felt that, for outside use, such a wide and uniform characteristic as the velocity microphone provided was not essential.

The inductor device is a pressure-type instrument, but a reduction has been made in the faults common to

such pick-up instruments insofar as Nemo requirements are concerned.

With the greatest sensitivity for a given weight, according to the manufacturers, the inductor microphone is surpassed in quality only by the more costly velocity type.

Its advantages for outside pick-ups include the fact that it is insensitive to wind and mechanical vibrations. Nor is it affected by temperature or humidity.

To simplify its remote operation, the microphone does not require any external excitation or power supply. A closely linked amplifier is also unnecessary. Also, it is light and sturdy, facilitating its portability.

In design, the new microphone consists essentially of a single conductor rigidly coupled to an elongated alumi-

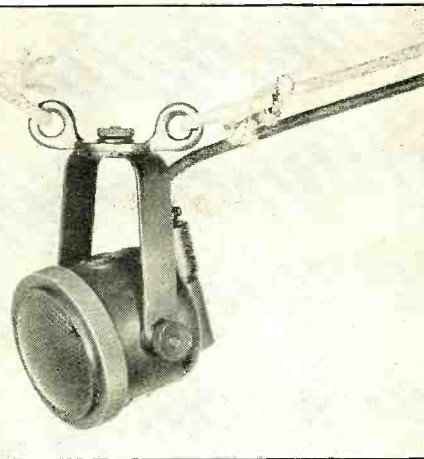

"HANGING" INDUCTION MICROPHONE

*This is the novel 50-A inductor microphone, shown with a suspension mounting using two cords to place it in the proper position above the performers*

num diaphragm. Corrugation of the diaphragm permits the system to vibrate freely. The sound waves reaching the diaphragm cause the single-conductor element to vibrate in the field of a permanent magnet. This generates a voltage across the conductor, which is closely proportioned in frequency and amplitude to the impinging sound pressure.

Proportion acoustic circuits are included to highly damp the natural resonance of the moving system and to otherwise con- (Continued on page 456)

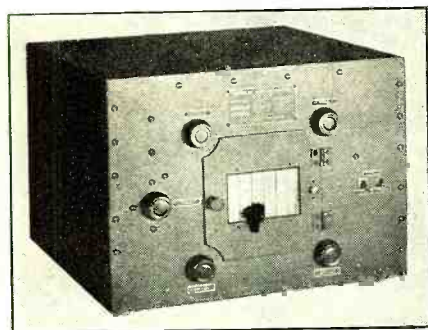

THE COMPLETE UNIT

*The cathode-ray modulation indicator, showing control knobs and the visual window*

FOR a considerable time, Dr. Vladimir K. Zworykin, research engineer of RCA-Victor Laboratories, has engaged in intensive research and development with the cathode-ray tube. The versatility of this tube is demonstrated by its latest application in a new transmitter device known as the cathode-ray modulation indicator.

Under the regulations of the Federal Communications Commission, the practice has become standard in broadcasting stations to utilize efficient forms of modulation indicators.

The type 49-A device, from the laboratories, has many apparent advantages over other types. The unit is virtually automatic after an initial adjustment. Two switches—one for the tube heater and one for the sweep circuit—are provided.

## New Cathode-Ray MODULATION INDICATOR

John Strong

A glass window, measuring 2½ inches by 4 inches in the panel door serves both as a tube-protector and as a chart for indicating the modulation percentage. The window is marked with two black and three red lines to permit the operator to gauge percentage modulation on both negative and positive peaks.

The vertical deflection is controlled by a potentiometer supplying the magnetics deflectors, while horizontal deflection is controlled by the pick-up tuning and by a second anode potentiometer. Beam focus is controlled by the first anode potentiometer and brilliance by the grid potentiometer.

Anode potentials are normally obtained from the transmitter plate supply, for which a 20-foot cable length is provided.

A chief advantage of the cathode-ray modulation indicator is that it operates directly from the R.F. carrier and re-

quires no rectifier as is usually essential for other kinds of modulation indicators. This eliminates the possibility of distortion due to rectification and gives a true visual picture of the antenna output. Adjustment is such that, with the pick-up circuit tuned, the deflection without modulation just reaches the two inner lines which are black. A positive 100 percent (Continued on page 449)

### "MODULATION PICTURES"

*The visual window of the device as it would look when a carrier is being modulated 100 percent*

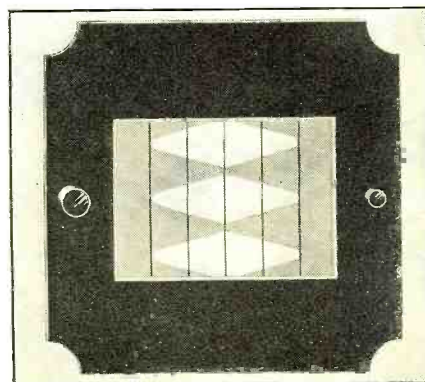

# RADIO in INSTALLATION

(Shielding and

The aviation field offers definite men who are well versed in the This is the second of an exclusive giving accurate data on the

Henry W.  
Part

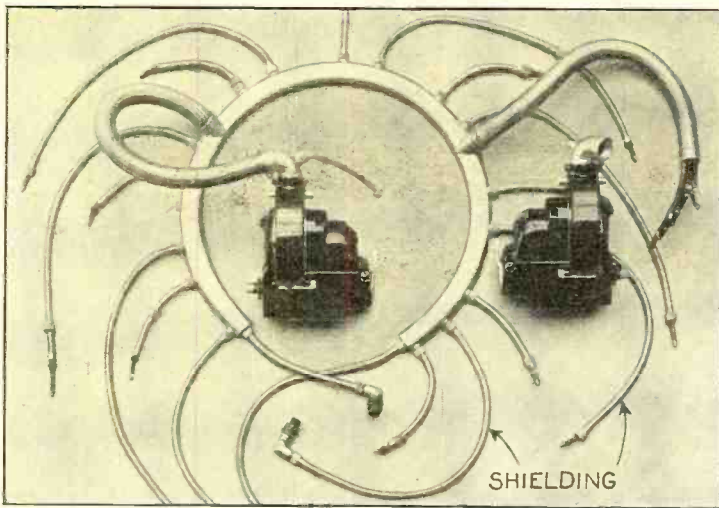

### ENGINE SHIELDING HARNESS

Figure 1. Here is a manifold-type shielding harness for the aviation engine's ignition system

THE success of an aircraft radio installation depends to a very great extent on the efficiency of the shielding and bonding work done on the airplane, and the care with which it is maintained. For this reason, proper understanding of the problems involved and careful and accurate execution of the work are of the utmost importance to the aircraft radio man. It should be his aim to make the shielding and bonding job as perfect as possible; yet, at the same time he should guard his client's pocketbook against excessive costs, disproportionate to the advantages gained. Shielding and bonding an airplane is an expensive job, usually running into a figure higher than the cost of the radio itself.

The informed radio man can, however, largely control the costs by careful selection of proper equipment and materials, and by omitting certain operations which, in his particular installation, may be superfluous. Thus, an airplane carrying both transmitting and receiving equipment, intended for frequent flying through any weather, will need a more complete protection of its radio system; while in a small private airplane, carrying only a low-gain receiving set, the installation may be somewhat simplified, without detracting

materially from its usefulness under ordinary flying conditions.

By *shielding* is meant confining electrical fields of the airplane electrical system so as to eliminate interference with radio operation. The shielding of an airplane may be divided into two groups: primary, comprising the engine ignition system (magnetos, high-tension leads to spark plugs, and the spark plugs); and secondary, comprising the low-tension wiring system, switches, etc.

For shielding the primary group, it is best to use a complete "shielding harness", of which several types are available commercially. A typical shielding harness for a 9-cylinder radial engine is shown in Figure 1. It consists of a continuous metallic conduit carrying high-tension leads from magnetos to spark plugs; the shielding shown is of the manifold type, all leads being carried in a manifold from which shielded lines lead off to individual spark plugs.

In Figure 2 we see the individual lead type of shielding, popular with private airplanes; this is available either as a complete harness or the shielded high-tension cable can be bought separately and the harness made and fitted on the job.

Both types are sound electrically, and the final selection will depend on other factors: the former is more expensive, but once installed, is less liable to damage by wear and tear; the latter is always open for inspection and can be serviced with greater ease; oil and mois-

ture may collect in the manifold type; individual lead type is more subject to mechanical damage; the weight is often also a factor.

For shielding magneto blocks, ready-made magneto shields are best. The shields should fit snugly to magneto covers. (See Figure 3.) The shielding harness must connect electrically to the magneto shields.

Two types of spark-plug shields are shown in Figures 4 and 5. The general requirement for all spark-plug shields is that they form a secure electrical contact from engine to harness; that they be sturdy mechanically and easy to service; and that while protecting the spark plugs from accumulations of oil and moisture, they still permit a certain amount of "breathing," to equalize the air pressure inside and outside the spark-plug shield at varying altitudes, and also to relieve a certain amount of seepage of gasoline mixture from the

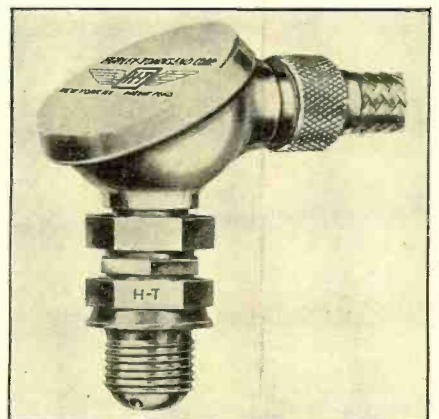
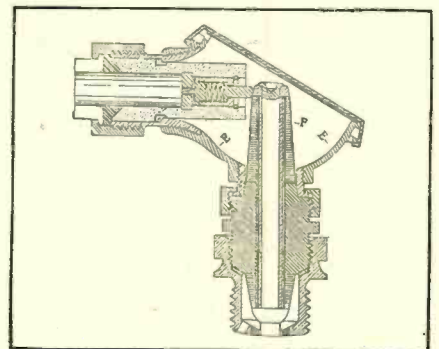

### A SHIELDED ENGINE

At left is a view of an aviation engine with shielded cables and harness in place. Figure 7, below: A swaging tool for applying metal ferrules to the ends of braid metal conduits. Figure 4, right: A structural diagram and a photographic view of a standard type of spark-plug shield

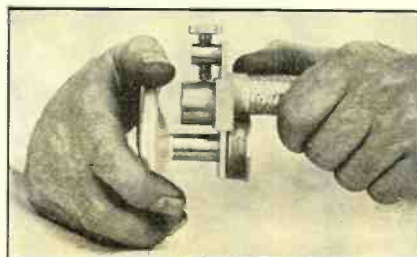



# AIRCRAFT

## AND DATA

### *Bonding Data)*

chances for advancement to radio application of radio to aircraft. series of articles on aircraft radio, problems of installation and service

### Roberts

*Two*

cylinders, which not infrequently occurs at the spark plugs. If the spark-plug shield cannot "breathe," the gases will seek to escape through the harness, ruining insulation on the high-tension cables and necessitating frequent replacements. With changes in altitude and temperature, there usually is a certain amount of condensation inside spark-plug shields, and they should have a provision for collecting this moisture, until again evaporated, without the danger of short-circuiting the ignition system.

A metal "can" cover for the generator field (if one is used), and a 4-mfd. condenser, across the regulator, will go far in eliminating interference from these sources. Storage batteries must be enclosed in metal containers; and if a battery is used for ignition, a filter in the battery line will materially improve radio performance.

The secondary group shielding is al-

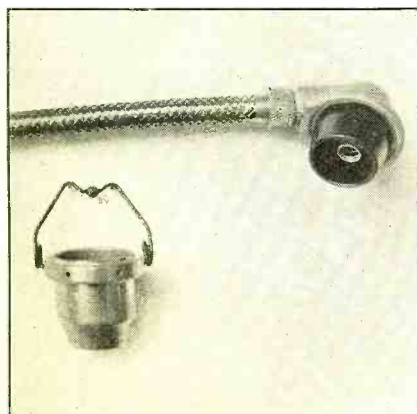
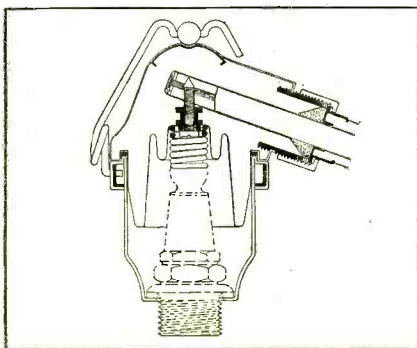

most as important as that of the primary group, and once you have the airplane's "insides" opened up, you should shield as many items in the secondary group as possible—preferably all. The only way to have perfect radio reception is to have perfect shielding—or as near perfect as the pocketbook permits.

If a booster is used, it must be completely shielded, whether it be of the magneto or the buzzer-coil type. Ignition switches must be shielded by enclosing them in metal boxes. The leads from the booster and the switches must be led through a flexible, metal-braided shielding or through a metal conduit; the latter should be used wherever mechanical protection of the wiring is also desired.

Electric navigation and landing light wiring is usually found already shielded, and a mere inspection will normally suffice. All electric switches, junctions, fuses, etc., should be enclosed in spark-proof metal boxes, and the shields connected electrically to the wire-shielding conduits. The radio apparatus itself (and its wiring) is, of course, already shielded.

An often overlooked source of trouble is the electric tachometer, leading from the engine to the instrument board, where the number of engine revolutions per minute is indicated. If the tachometer is of the mechanical type, with a flexible metal shaft rotating within its flexible housing (like a dentist's drill), it should be grounded to eliminate possible interference.

Still another item is the comparatively seldom-used "thermo-couple" for

#### OTHER SHIELDING ELEMENTS

Figure 5, at left: Another type spark-plug shield, shown by drawing and photograph. Figure 2, below: Individual-lead type shielding harness attached to magneto. Figure 3, at right: Left and right magneto block shields

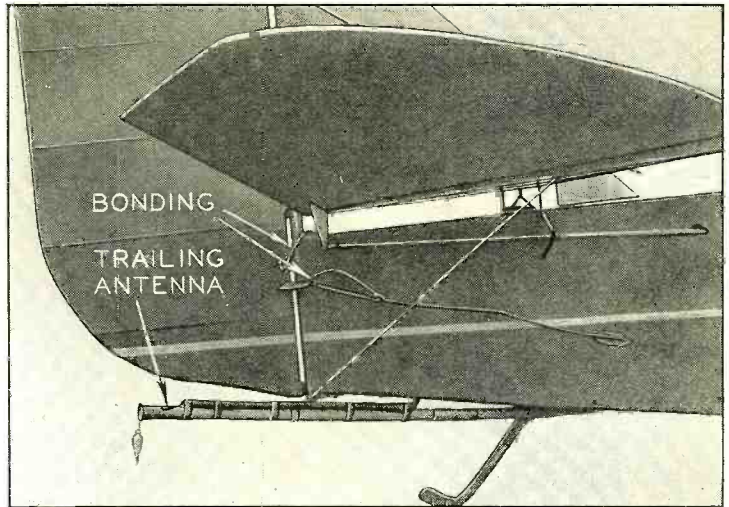
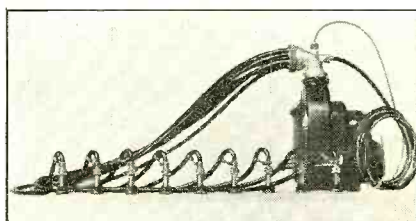

#### TYPICAL PLAIN BONDING

Figure 6. A clear illustration of the method of bonding tail-control surfaces is given here

measuring electrically engine temperature (connected to an electric thermometer on the instrument board). Several thermo-couples are often found, giving temperature at the head and at the base of different cylinders, with one or more switches on the instrument board to secure the desired reading. Such thermo-couple installations should also be completely shielded.

By Bonding is meant connecting, electrically, all metal parts of the airplane to provide a good counterpoise for the radio set. In addition to providing a good "ground," bonding also eliminates the possibility of static electrical charges collecting on the separate parts of the airplane structure, particularly on control surfaces, which may cause objectional noises in radio reception, and even sparking. The sparking may assume proportions of a fire hazard, especially when flying through electrical storms. Bonding is best done at the factory, at the time the airplane is constructed; almost all airplanes built during the last four or five years are already bonded. It will, however, be necessary for the serviceman to check the bonding to see if it is effective, repairing and adding where necessary.

For bonding, use metal strips or flexible bonding braid, soldering it in place, or clamping. Bonding connections should be of low resistance. Parallel metal members (*Continued on page 451*)

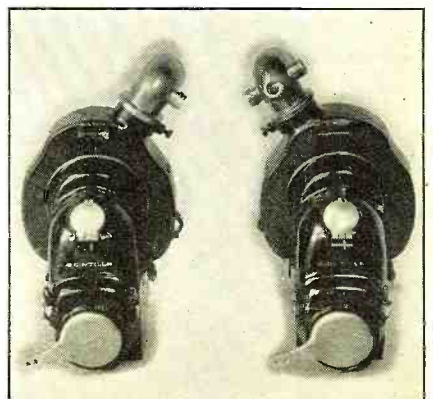

# A Frank Discussion of OHMMETER DESIGN

Herein is presented an analysis and discussion of various ohmmeter circuits, their attendant errors and ways of obtaining greater accuracy

Alfred R. Gray

Part One

IN discussing the design of ohmmeters, it would, perhaps be best to begin on the simplest form of ohmmeter, such as the one shown in Figure 1A. For calculating resistances for such an outfit, the formula would be

$$R_{FC} = \frac{1000 E}{I_M} - R_M$$

where  $I_M$  is the current flowing through the milliammeter  $M$ , where  $R_{FC}$  is the value of the resistance placed in the circuit and where  $R_M$  is the internal resistance of the meter. Or,  $M$  may be a voltmeter with a resistance built in. In the latter case  $E$  would, of course, be equal to the full-scale voltage reading of the meter. This ohmmeter is actually of little use for accuracy, as  $E$  changes with use as well as temperature. For example, when  $E$  drops to 75 per cent of its original volume, the calculated reading would drop from 150 ohms (near full-scale) to perhaps 1500 ohms (near .75 scale), while the center-scale reading would be some 67 percent in error.

Figure 1B shows an arrangement frequently found in low-priced analyzer-ohmmeter combinations. Twenty-five

percent of the calibrating resistance has been made variable, so the pointer can be adjusted to full-scale as the battery voltage drops 25 percent. This practice eliminates the error of from 150 to 1500 ohms mentioned above; but a 25 percent error is still possible, for the following reason. If the resistance being measured is equal to the calibrating resistance, there will be twice the resistance in the circuit, and the meter will read half-scale. Thus the resistance marking at half-scale is always equal to the calibrating resistance (the calibrating resistance being considered as including the meter resistance, although the meter resistance is sometimes low enough to be unimportant). Therefore, if this calibrating resistor is changed 25 percent for voltage and adjustment the center-scale reading (and all others) will be 25 percent in error. This error can be changed to 12.5 percent by making the center-scale value equal to

$$R_M + R_{FC} + \frac{R_{VC}}{2}$$

But 12.5 percent error is objectionable, except for crude measurements, because to this must be added meter errors and other errors mentioned later. Of course, if the meter has a magnetic shunt adjustment, this circuit would have the same accuracy as Figure 1C, discussed below.

Figure 1C makes a very accurate ohmmeter, providing  $R_M$  is low compared to  $R_{FC}$ .  $R_{FC}$  should be ten times  $R_M$  at least, when an error of  $\pm 3$  percent will be introduced, in addition to other unavoidable errors (amounting to  $\pm 6$  percent, as pointed out later). If  $R_{FC}$  is made 30 or 40 times  $R_M$  and an 0-1 milliammeter used, this error will be reduced to .75 of 1 percent or better, if the following sources of error are minimized:

(1) Error caused by variation of the calibrating resistance (which includes the meter and its battery-compensating

circuit) as explained in the discussion of Figure 1B. This can be reduced, for example, from a  $\pm 7.1$  percent to a  $\pm .55$  percent error by reducing  $R_{FC}$  to make the total calibrating resistance correct when the battery-compensating adjustment is at center (instead of the 1.5-volt end, as is often done).

(2) Error caused by variation of the calibrating resistance due to variation of the internal resistance of the battery. Battery resistance varies:

(a) With current drain, or total resistance in the circuit, which includes the calibrating resistance and the resistor under measurement—the latter being a variable. When the meter reads .25 scale the resistor under measurement is three times the calibrating resistance and the total resistance in the circuit is four times the calibrating resistance. When the meter reads half-scale the resistor under measurement is equal to the calibrating resistance and the total resistance in the circuit is twice the calibrating resistance. When the meter reads .75 scale the resistor under measurement is one-third the calibrating resistance and the total resistance in the circuit is 1.33 times the calibrating resistance. To assume that the average total circuit resistance between .25 and .75 scale (the accurate portion of the scale) is twice the calibrating resistance would be nearly correct, but a slightly lower average error will result if the average total circuit resistance is figured at 1.67 times the calibrating resistance. This value should therefore be used in figuring the current drain at which the battery resistance correction is to be made.

(b) With use. As the battery voltage drops from 1.5 volt to 1.2 or 1.13 volt per cell the internal resistance probably increases on an average from 30 to 100 percent, depending upon the "severity of service," but as the voltage drops below 1.13 volt percent the internal resistance increases more rapidly. In order to prevent the use of batteries that have developed high internal resistance, the lower limit of the voltage-compensating adjustment can be fixed at some value between 1.13 and 1.2 volts per cell. The upper limit should be about 1.6 volts, in order that a full-scale adjustment can always be obtained, when using new batteries at high room temperatures. By fixing these limits another result has been accomplished—the range has been spread over the full rotation of the knob. This makes a more accurate adjustment possible at full scale.

(c) With age. The internal resistance probably increases 20 percent with a

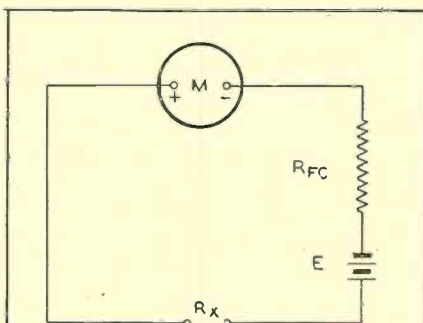

FIG. 1A

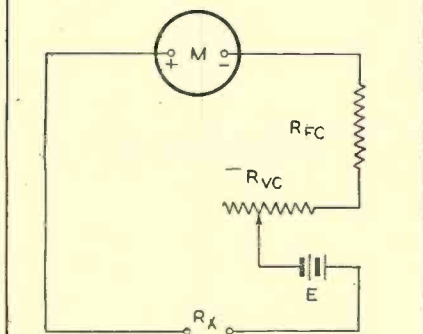

FIG. 1B

### LEGEND FOR TEXT AND ILLUSTRATIONS

- $I_M$  - (IN TEXT) FULL SCALE CURRENT (RANGE) OF METER (MILLIAMPERES)
- $E$  - BATTERY (VOLTS)
- $R_{FA}$  - ADDITIONAL FIXED RESISTOR (OHMS)
- $R_{VA}$  - ADDITIONAL VARIABLE RESISTOR (OHMS)
- $R_{MA}$  - RESISTOR FOR ADJUSTMENT OF METER RESISTANCE (OHMS)
- $R_{FC}$  - FIXED CALIBRATING RESISTOR (OHMS)
- $R_{VC}$  - VARIABLE CALIBRATING RESISTOR (OHMS)
- $R_M$  - (IN TEXT) INTERNAL RESISTANCE OF METER (OHMS)
- $R_X$  - RESISTANCE BEING MEASURED (OHMS)

year of shelf life, or an average increase of 10 percent. Accordingly, if we increase the internal battery resistance, estimated at a current drain corresponding to a circuit resistance of 1.67 times the calibrating resistance [from (a) above], 30 to 100 percent, as determined by the size of the cell and the current drain [from (b) above], and another 10 percent [from (c) above], we will have as close an approximation as is possible to the average value of this more or less uncertain variable. R<sub>FC</sub> should be further reduced by this value [see (1) above] and the batteries changed at least once a year.

Figure 1D is a circuit which has not been used in more than one manufactured ohmmeter, to the author's knowledge. It is a companion circuit to Figure 1C, but due to its different structure is suitable for very low-range ohmmeters. In this circuit the resistor under measurement acts as a shunt on the meter. The rheostat R<sub>VA</sub> is adjusted to make the meter read full-scale with no resistor connected to R<sub>X</sub>. If R<sub>VA</sub> plus R<sub>FA</sub> is very high compared to

$$\frac{1}{\frac{1}{R_M + R_{MA}} + \frac{1}{R_{FC}}}$$

(the resistance of the calibrating circuit), the reading will drop to half-scale when the resistor under test is equal to the resistance of this calibrating circuit. For example, if the resistances R<sub>FC</sub> and R<sub>MA</sub> have been chosen so as to make (1) the meter read 4 ma. full-scale, and (2) the resistance of the calibrating circuit equal to 10 ohms, and if the resistor to be measured is 10 ohms, the range of the meter will obviously be doubled—half of the current (2 ma.) flowing through the resistor to be measured and the other half (2 ma.) flowing through the calibrating circuit (meter, etc.). In other words, the center-scale point of our meter in this case would be marked 10 ohms. However, it is not practical to make R<sub>FA</sub> + R<sub>VA</sub> high enough to make the reading drop to exactly half-scale. If R<sub>FA</sub> plus R<sub>VA</sub> were made very high, the battery voltage would also have to be very high, increasing the cost and reducing the portability. It is very convenient, from several points of view, to make R<sub>FA</sub> plus R<sub>VA</sub> equal to 30.7 times the calibrating circuit resistance. If this value is chosen, and a resistor equal to the calibrating circuit resistance is being measured, the calibrating circuit resistance will drop from 10 to 5 ohms, which will, in turn, drop the total resistance in series with the battery from 317 (307 + 10) ohms to 312 (307 + 5) ohms, which will increase the flow of current about 1.5 percent which, translated into error in resistance reading, would amount to over 5 percent. It is not necessary, however, to have this error appear. The ohmmeter scale can be corrected the proper amount, at all points, to eliminate this error. A small error will remain, caused by the variation from the 30.7-to-1 ratio, due to the change of R<sub>VA</sub> with battery voltage. This can be minimized by making the ratio correct when R<sub>VA</sub> is adjusted to

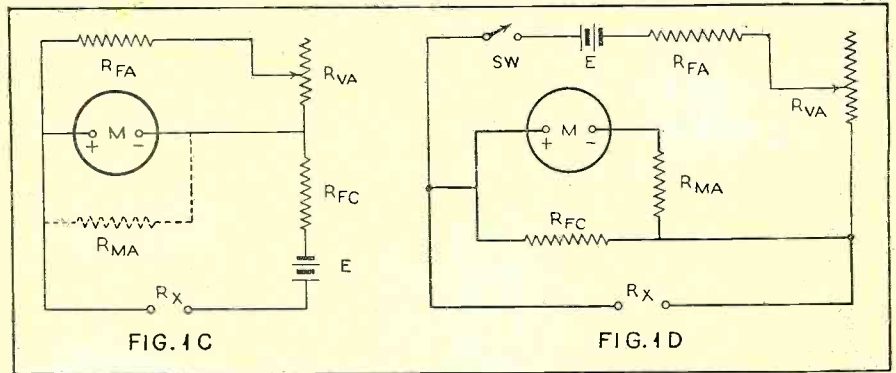

almost its center position. R<sub>FA</sub> plus R<sub>VA</sub> will then change about 15 percent, to provide an adjustment from 1.13 to 1.6 volts, which, when translated into error in the ohmmeter reading, will amount to about ± .6 of 1 percent; this, of course, in addition to other possible errors, discussed later. Another error will be caused by the resistance of the wiring and the test leads. The wires and leads that must be made low resistance are shown by heavier lines in the diagram. Battery resistance should be taken out of R<sub>FA</sub>, to insure proper voltage adjustment.

All of the popular multi-range ohmmeters and analyzer-ohmmeter combinations use circuits which differ little from the circuits already discussed, with the exception of one model of one manufacturer. A simplified arrangement of this exception is shown in Figure 1F. When the switches are in the lower position, the circuit is the same as Figure 1C and the accuracy obtained, considering all sources of error, will be about 6 percent, which is very good. When the switches are in the upper position the circuit is a little unusual. In order to obviate the necessity of using an expensive low-resistance switch, the meter has been left unshunted; and to obtain a low range, a fraction of a volt has been obtained by a voltage divider arrangement across a 4.5-volt battery. This circuit is subject to two errors. As R<sub>VA</sub> is adjusted from 1.5 volts to the 1.03-volt point, the resistance of the meter circuit (the meter and R<sub>VA</sub> in parallel) varies from 36.5 to 54 ohms; or is 45.25 ± 8.75 ohms. Now 45.25 + 14 + 8 = 67.25 ohms, for an average calibrating resistance, which is only a little over 1 percent less than a decimal submultiple of 68,000 ohms; but this average will change 8.75 ohms, with battery compensation, or about ± 12 percent, resulting in a possible ± 12 percent error from this cause alone.

This error is due to the low ratio of R<sub>FC</sub> to meter resistance, cautioned against in the discussion of Figure 1C. The second error is less than the above, but, on higher ranges, it could be large. It is caused by a decrease in voltage drop across the 8-ohm section, due to the lowering of the 8 ohms by the shunting effect of the rest of the circuit. When the resistance being measured is about 68 ohms, there would be a total of 135 ohms in parallel with the 8-ohm section, which would reduce it to 7.55 ohms. This would reduce the voltage drop 5.5 percent, which, in turn, would reduce the current through the meter 5.5 percent. This, expressed in terms of an increase in resistance reading, would be about 8 percent. This error could be reduced by a compromise increase in the calibrating circuit resistance, on the lower ranges.

Small meters, as used in test equipment, are usually calibrated to an accuracy of ± 2 percent of full-scale current. At half-scale they would be accurate to ± 4 percent (of half-scale, which is equal to ± 2 percent of full-scale). If (Continued on page 441)

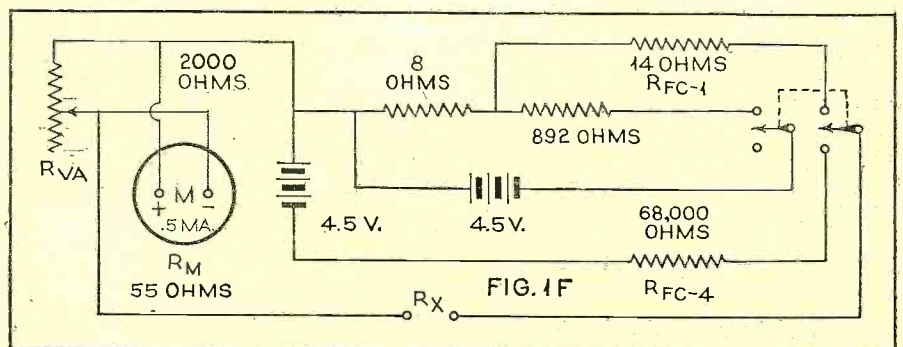
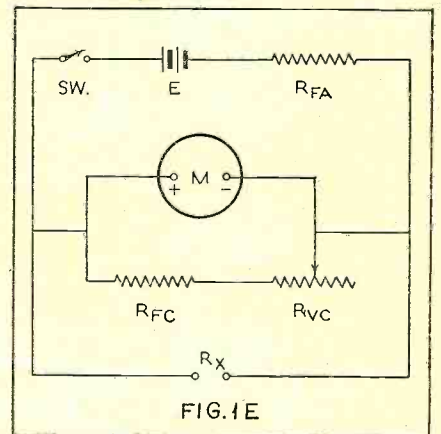

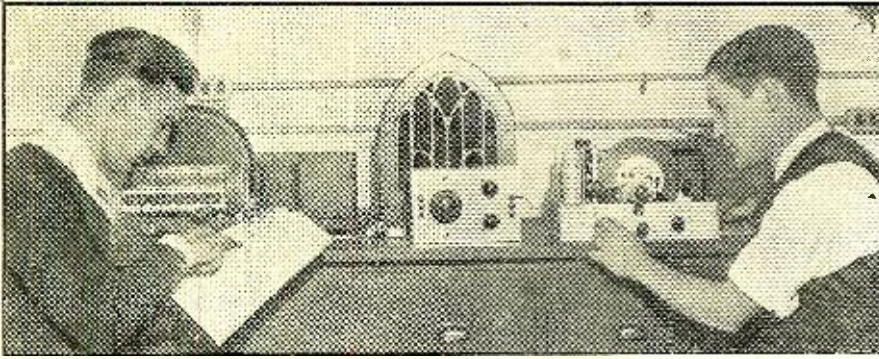

## THE DX CORNER

(For Broadcast Waves)

S. GORDON TAYLOR

**L**ISTENING posts have now been established (37 to date), distributed among 18 States, 4 Canadian Provinces and 3 foreign Countries—England, Sweden and Australia. The "welcome" mat is still out for those desiring appointments as Official RADIO NEWS Broadcast-Band Listening Post Observers. Any reader desiring to apply can do so by writing to the Broadcast Band DX Editor giving a summary of his DX accomplishments to date and expressing a willingness to submit regular reports to the DX Corner, if appointed. There are many States in which no appointments have yet been made; also numerous foreign Countries. Also there is room for additional appointments in the States and Countries already included.

### DX Tips

Don't forget that KDKA offers its regular DX tips broadcast every Saturday morning from 12:30 to 1 a. m., on a frequency of 980 kc., with a power of 50 kw. KFI, operating on 640 kc., with 50 kw., also offers a tips broadcast from 2:30 to 3 a. m. on Sunday morning. KFJ, 1300 kc., 1 kw., broadcasts tips daily at midnight. WHEF, 1500 kc., Kosciusko, Miss., broadcasts DX news every Monday and Wednesday after midnight, except the first week of each month.

### Advance DX Calendar

The International DX'ers Alliance, in *The Globe Circler* for November, give the following list of special DX courtesy programs. These special transmissions were arranged particularly for I.D.A. listeners, but the stations broadcasting the programs will be more than glad to have reports from any readers of the DX Corner. (All hours are E.S.T.)

Friday, December 7th, 1:30-3 a. m., LS2, Buenos Aires, Argentine, 1190 kc., 40 kw.  
 Sunday, December 9th, 2-3:10 a. m., Strasbourg, France, 859 kc., 17 kw.  
 Monday, December 9th, 2-3:30 a. m., LR5, Buenos Aires, Argentine, 830 kc., 25 kw.  
 Monday, December 10th, 3-4 a. m., YV6RV, Valencia, Venezuela, 675 kc., 3 kw.  
 Tuesday, December 11th, 3-4 a. m., CP4, La Paz, Bolivia, 1040 kc., 10 kw.  
 Wednesday, December 12th, 2:30-3:30 a. m., CPX, La Paz, Bolivia, 1230 kc., 5 kw.  
 Friday, December 21st, 1-3 a. m., HJN, Bogota, Colombia, 682 kc., 1 kw.  
 Thursday, January 10th, 12:10-1:30 a. m., EAJ7, Madrid, Spain, 795 kc., 10 kw.  
 Wednesday, January 16th, 12:01-2 a. m., CT1GL, Parede, Portugal, 1031 kc., 5 kw.  
 Friday, January 18th, 11 p. m.-5 a. m.

(Saturday), KGVO, Missoula, Montana, 1200 kc., 1 kw.

Sunday, January 20th, 1-2 a. m., PP, Paris, France, 959 kc., 100 kw.

Tuesday, January 22nd, 2-3 a. m., LS2, Buenos Aires, Argentine, 1190 kc., 40 kw.

Wednesday, February 6th, 2-3:30 a. m., Toulouse, France, 913 kc., 60 kw.

Sunday, February 10th, 2-3:30 a. m., LR5, Buenos Aires, Argentine, 830 kc., 25 kw.

The National Radio Club announces the following special DX broadcast dedicated to this organization: January 6th, Sunday, 3:10-5:10 a. m., HIX, Santo Domingo, D. R., 1270 kc., 15 kw.

### DX Contest

The International DX'ers Alliance announces that a new contest was started October 1st, to run until August 31, 1935. This contest is open to all I.D.A. members, as well as to members of the Short-Wave Pioneers—the old-timers' affiliate of the I.D.A. All stations reported in this contest must be verified and the verifications submitted to the contest judges. A number of valuable prizes will be offered and rewards will be made on a point basis. No station less than 2000 miles distant is considered. Each verified report is given an initial rating of 10 points, but to this may be added additional points for low-power stations and for unusual mileage. Thus every qualified station will have a point value of at least 10, but certain stations will run as high as 16 points.

If further information is desired on this contest, it may be obtained by writing to the International DX'ers Alliance, Bloomington, Illinois.

### Canadian Monitor Schedule

It seems impossible to obtain the frequency check schedule from the Canadian Government, but the *DX News*, weekly organ of the National Radio Club (York, Pa.), as a result of a check-up made through its membership, gives the following list. These transmissions occur on the 18th, 19th and 20th of each month. The hours shown are E.S.T.:

1:01-1:09, CFCY, Charlottetown, P. E. I., 630 kc.

### 3YA CHRISTCHURCH, NEW ZEALAND

*It is reported that this station operating on 720 kc. with 2.5 kw. power will shortly increase its power to 10 kw. The large building shown here houses the transmitter. At the right are the engineers' cottages and in the background one of the two 300-foot masts.*

### Official RADIO NEWS Broadcast Band Listening Post Observers

Aitner, Jacob, Brooklyn, N. Y.  
 Ansell, William H., Saskatchewan, Canada  
 Beal, William W., Jr., Lawrence, Massachusetts.  
 Biss, F. L., Brittmount, Minnesota  
 Blodgett, Lee F., Creston, Iowa  
 Bohm, John S., Malung, Sweden  
 Burleigh, Fred, Meriden, Connecticut  
 Caraven, C. R., British Columbia, Canada  
 Coales, R. T., Hants, England  
 DeMyer, John, Lansing, Michigan  
 Dixon, Marvin D., Shelby, North Carolina  
 Eck, Howard W., East Lansing, Michigan  
 Ellis, George, North Stockport, England  
 Everly, Ray E., Newton, Illinois  
 Gootee, T. E., Springfield, Missouri  
 Goss, Edward F., Brooklyn, New York  
 Halpern, Karl I., Brooklyn, New York  
 Hough, Robert, New Rochelle, New York  
 Hunt, Randolph, Leucadia, California  
 Hynes, A. L., Clarendville, Newfoundland  
 Ingle, George F., New South Wales, Australia  
 Kalmbach, John C., Jr., Buffalo, New York  
 Kimmons, E. L., Austin, Texas  
 Long, C. H., Winston, Missouri  
 Roberts, E. R., Indianapolis, Indiana  
 Roberts, Evan B., Danvers, Massachusetts  
 Robinson, Philip H., Shelburne, Nova Scotia, Canada  
 Schneider, Jack B., Garwood, New Jersey  
 Schofield, R. W., Missoula, Montana  
 Shields, Donald W., Roseville, Ohio  
 Southward, Richard J., Toledo, Ohio  
 Stokes, Joseph, Swissvale, Pennsylvania  
 Tomlinson, R. H., Port Chester, New York  
 Walker, Alan B., Princeton, New Jersey  
 Wilkinson, Henry, Jr., Baltimore, Maryland  
 Winkley, Warren E., Hughson, California  
 Woodhead, J. H., Monarch, Wyoming

1:11-1:19, CJLS, Yarmouth, Nova Scotia, 1310 kc.  
 1:21-1:29, CFPL, London, Ont., 730 kc.  
 1:31-1:39, CJKL, Kirkland Lake, Ont., 1310 kc.

(Courtesy—Eric Watson, Vice Pres., N. Z. DX Radio Assn.)

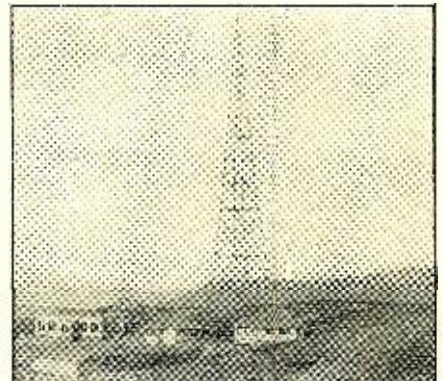

1:41-1:49, CHNC, New Carlisle, Quebec, 1210 kc.  
 1:51-1:59, CFNB, Fredericton, New Brunswick, 550 kc.  
 2:01-2:09, CJCB, Sidney, Nova Scotia, 1240.  
 2:01-2:09, CJCB, Sidney, Nova Scotia, 1240 kc.  
 2:11-2:19, CFCH., North Bay, Ont., 930 kc.  
 2:21-2:29, CRCS, Chicoutimi, Quebec, 950 kc.  
 2:41-2:49, CKCL, Toronto, Ont., 580 kc.  
 3:01-3:09, CHSJ, St. Johns, New Brunswick, 1120 kc. CKTB, St. Catherine, Ont., 1200 kc.  
 3:11-3:19, CFCO, Chatham, Ont., 600 kc. KCCV, Quebec, Quebec, 1310 kc.

**Iowa on the Air**

The broadcast stations of Iowa are pulling an unusual stunt beginning at midnight and ending at 4:30 a.m., E.S.T., December 16th. At least, plans are set if the approval of the Federal Communications Commission is obtained. As planned now, the various stations of the state will go on the air for half hour periods, one after the other, in accordance with the schedule printed below. For listeners who need Iowa stations to fill out their logs, this will present an exceptional opportunity.

WOC-	Des Moines	1000 kc.	12:00	1:00 am. CST.
WHO	Iowa City	880 kc.	1:00	1:30 am. CST.
KFNF	Shenandoah	890 kc.	1:30	2:00 am. CST.
KFJB	Marshalltown	1200 kc.	2:00	3:00 am. CST.
WOI	Ames	640 kc.	2:00	2:30 am. CST.
KMA	Shenandoah	930 kc.	2:30	3:00 am. CST.
WMT	Waterloo	600 kc.	3:00	3:30 am. CST.
KSO	Des Moines	1320 kc.	3:00	3:30 am. CST.
KSCJ	Sioux City	1330 kc.	3:30	4:00 am. CST.
KGCA	Decorah	1270 kc.	3:30	4:00 am. CST.
KWLC	Decorah	1270 kc.	4:00	4:30 am. CST.
KFGQ	Boone	1370 kc.	4:00	4:30 am. CST.
KOIL	Council Bluffs	1260 kc.	4:30	5:00 am. CST.
KWCR	Cedar Rapids	1430 kc.	5:00	5:30 am. CST.

A number of prizes are to be given to listeners reporting on these broadcasts. All reports entered in the competition are to be sent direct to the stations logged, but reports on the complete series of broadcasts should be sent to Robert W. Gorsuch, 431 Main St., Grinnell, Iowa; or Don Barnes, 521 Spring St., Grinnell, Iowa, who are promoting, managing, and supervising this special event. In submitting reports, details of the programs heard should be included and reports mailed in no later than midnight, Monday, December 18th.

**Reports from New York**

The following information comes from 3 Official L.P.O.'s in New York. Observer Tomlinson (Post Chester) writes: "Reception so far this season rather poor. High static and weak signals prevail six nights out of seven. However, now and then a good night is had. The past week the Europeans made their appearance in this location with Hilversum, 1195 kc.; Berlin, 841 kc.; Hamburg, 904 kc.; Poste Parisien, 959 kc.; and Praha, 638 kc. being logged. So far Post Parisien is the best of the Europeans. Trans-Pacific reception has improved greatly the past week, with 2BL, 855 kc., being the star performer. Next in signal strength is 2CO on 560 kc., and then 2YA on 570 kc. Other trans-pacific stations heard were 7ZL, 580 kc.; 3AR, 610 kc.; 5CK, 635 kc.; 2FC, 665 kc.; 6WF, 690 kc.; 5CL, 730 kc.; 4QG, 760 kc.; 3LO, 800 kc.; 4RK, 910 kc.; 2GB, 949 kc.; 5DN, 960 kc.; 2UE, 1025 kc.; and 2KY, 1071 kc. These last vary from R4 to R7. No Japanese heard so far this year. "South Americans are excellent at times when interference isn't bad. LS2, 1190 kc., heard most every night, as well as YV1RC on 960 kc. LR4 on 990 kc., has been heard

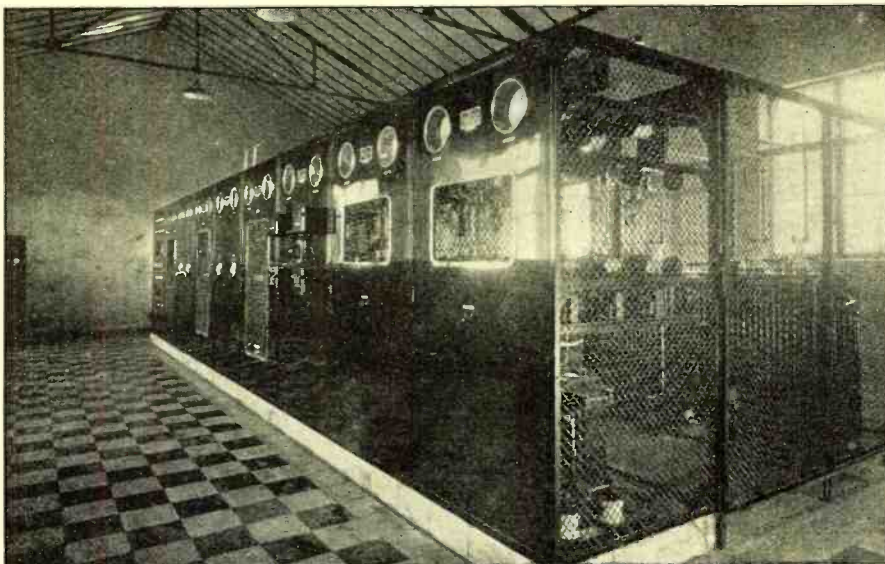

**LS2, RADIO PRIETO, BUENOS AIRES**

*Operating with antenna power of 30 kw. on 1190 kc. this station is regularly heard by DXers of the U. S. and Europe. The modern half-wave vertical antenna is shown at left.*

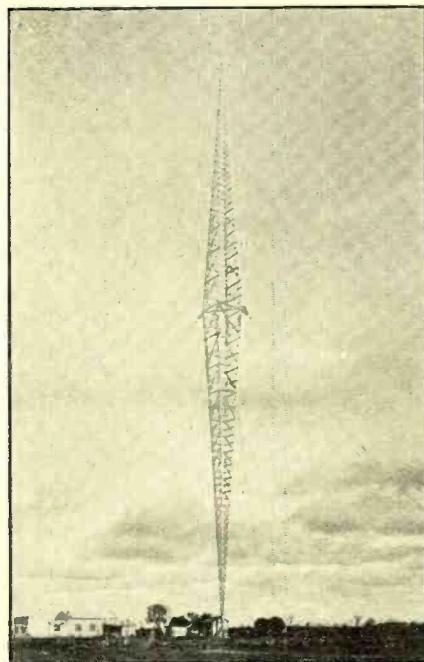

(Courtesy—Manuel Barbera. "Sentonia," Buenos Aires)

Observer Kalmbach (Buffalo) has been tuning in on the F.C.C. Monitor Schedules with excellent results. He added about 40 stations to his log in 3 days during these early morning transmissions, October 3rd to 5th. This suggests that other fans in his vicinity (Buffalo) might well follow his example.

**Report from Massachusetts**

Evan B. Roberts, Official L.P.O., Danvers, Mass., was mentioned earlier in this department as one of the prize winners in the recent IDA DX contest. In an interesting letter, dated September 23rd, he describes reception conditions for his locality during the past few months. Here is his report: "Conditions at the present time point to a DX season every bit as good as last season. Radio Normandie was heard occasionally all summer long. LS2, Buenos Aires, 1190 kc., has been heard here for the past five weeks, during the evening from 6:30 to 7:30 p.m., E.S.T. The Australian and New Zealand stations have started to come in here. Reception of these stations is not at its best yet. A little more darkness in the mornings is necessary. The following T-Ps have been heard between 4:45 and 5:30 a.m., E.S.T.: 2CO, 2YA, 3AR, 5CK, 2FC, 3YA, 4QG, 3LO, 2BL, 2GB, 2UE, 2KY, 2UW, 4BC, 2SM, 4BH, and JO1K. 3LO, 2GB, 2UW are new ones for me.

"The European stations have also started to come in. Reception of these is not real good as yet. More darkness in the afternoon is necessary. The end of D.S.T. will surely make a difference. The best time to hear these Europeans, at the present writing, is from 5:30 to 7:00 p.m., E.S.T. The following stations have been heard during the week ending September 23; all of them on the speaker, R6—R9. Milan, 814, Rome, 713 and Turin, 1140 kc., all in Italy; Stuttgart, Germany, 574 kc.; EAJ-1 Barcelona, Spain, 795 kc.; Fecamp, France, 1456 kc.; Toulouse, France, 913 kc.; London Regional, 877 kc., and West Regional, 977 kc. Last season I heard as many as twenty Europeans, between 4 and 7 p.m. As many as thirty were heard between 12 and 4 a.m. The season ran from October well into April."

twice with excellent signal strength after WBZ left the air. LR10 on 790 kc., was logged once at 9:30 p.m. OAX, same frequency, heard at 10 p.m. These are heard when WGY is fading. LR5 heard several times near 10 p.m. when KOA fades. TGW on 565 kc., is heard each Sunday with wonderful volume on his DX transmissions."

Observer Hough (New Rochelle) has been ill and has therefore had little opportunity for DX work. However, he has listened in some, and reports: "Static has been bad with an occasional night when it would let up a bit. The West Coast continued to come through good for this time of the year.

"October 13, midnight-12:45 a.m., E.S.T., Hamburg, Germany, 904 kc., received with signal strength R8 when at maximum, and fading at times completely out.

"October 16, midnight-12:30 a.m., E.S.T., Frankfurt, Germany, 1195 kc., received with R8 strength but rapid fading, always coming back quickly.

"October 18, 1:30-2 a.m., E.S.T. Bordeaux, France, 1077 kc., received about R7—very little fading but static level was quite high, making program hard to identify."

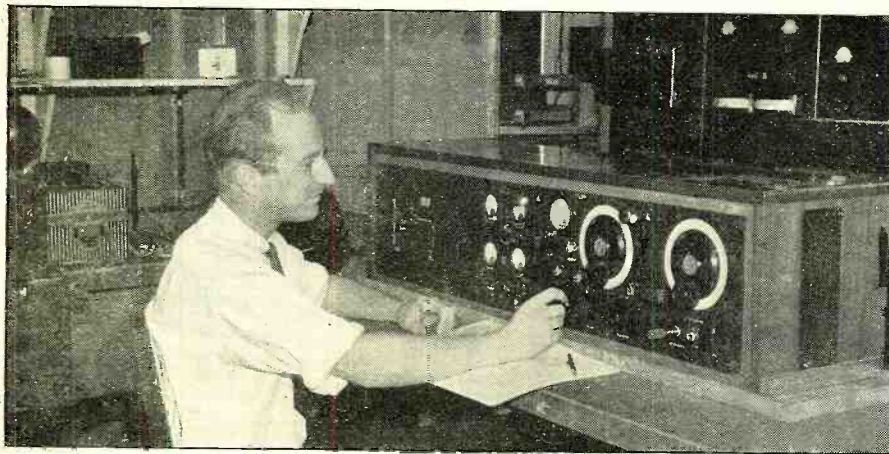

**A NEW FREQUENCY MONITOR AND STANDARD**

The Federal Communications Commission may discontinue the monthly monitoring schedules and instead check frequencies of all stations during operating hours by means of a fleet of monitor trucks equipped with the newly developed Westinghouse Portable Frequency Standard shown here. This unit, which consists of a crystal oscillator, harmonic generator, and receiver, is capable of checking signal frequencies to an accuracy of 3 parts in 1,000,000 which means that a station operating on 1,000 kc. can be checked to within 3 cycles.

**Heard in Connecticut**

Official L.P.O. Burleigh reports hearing the following Australians between 5:00 and 6:30 a.m., E.S.T.:

Call	Location	Kc.
2BL	Sydney	855 kc.
2CO	Corowa	560 kc.
3AR	Melbourne	610 kc.
5CK	Crystal Brook	635 kc.
2FC	Sydney	665 kc.
4QG	Brisbane	760 kc.
3LO	Melbourne	800 kc.
2GB	Sydney	950 kc.
2UW	Sydney	1125 kc.
4RK	Rockhampton	910 kc.
4BC	Brisbane	1140 kc.

He also reports TGW, 565 kc., Guatemala City, as coming in strong every Sunday morning until around 6:00 a.m.

**Report from Maryland**

Official L.P.O. Wilkinson writes:

"I have been hearing LR8, LR4, and LS2 at very good volume and audibility under stations WHAM, WBZ, and WOAI respectively for the last month, but LS2 was the best. A new station on 1348 kc. has been heard here at very good volume between 8 and 9:30 p.m., E.S.T. It has been reported as being in Lima, Peru, and its call is OD4K. Another new one on about 674 kc. also has been heard here at very good volume and a few say it is LS4 and others say it is YV6RV of Valencia, Venz."

**Report from Nova Scotia**

Official L.P.O. Robinson, Shelburne, N. S., covers only six days' reception during the latter part of October. He reports: (Time—E.S.T.)

POSTE PARISIEN, 961 Kc., Paris, R8, QSA3, best 5:30 p.m.  
 11RO, 713 kc., Rome, best about 5:15 p.m. R7.  
 TOULOUSE, 913 kc., best about 5:15 p.m.

**October 20th**

Reception poor or nil from Europe. LS2 fair at 5:45 p.m.

**October 22nd**

Europeans poor.  
 YVIRC, 960 kc., R8, QSA5 at 6:00 p.m.

**October 23rd**

CARDIFF, 977 kc., Wales, very good, R7 at 6:30 p.m.  
 11RO, 713, Rome, very good, off air at 6:00 p.m.  
 POSTE PARISIEN, 961, usually best before sign-off at 5:30 but on Tuesdays on until 6:00 with English announcements.  
 TOULOUSE, 913 kc., until sign-off at 6:00.  
 STUTTGART, 574 kc., very good at 5:45.  
 ATHLONE, 565, R8 at sign-off 6:00.  
 EAJI, Barcelona, 795, fair at 5:30.

CT1GL, 1031, Parede, Portugal. Very good from 5:30 to sign-off at 6:00 playing records.  
 ROME, 713, best 5:15-5:30.  
 FRANKFURT, 1195, Germany, R8, QSA, 5:35-6:05  
 HAMBURG, 904 kc., Germany, occasionally reaches R7, 5:45  
 BUDAPEST, 545, Hungary, R8, QSA5, 5:45-6:15 (off)  
 VONF, St. John's CHANGED to 970 kc., R8 at 6:40  
 British and German stations on until 7:00 p.m.

**October 24th**

Europeans poor. Static bad.  
 LS2 very good (1190) from 5:00 until WOAI comes in about 6:15-6:30.  
 LR5 appears (830) about 9:00 and good until sign-off about 9:45. Occasionally KOA appears about 9:00 spoiling reception.  
 YVIRC, 960, Caracas, R8 from 6:00 to 6:30.  
 LR5, 830, Buenos Aires, R9, QSA5 at 9:00 p.m.

**October 29th**

BORDEAUX, 1077, France, R8 at 4:45, good until 5:15.  
 TURIN, 1140, Italy, R8, QSA5, at 5:00 p.m. faded away  
 WALES, 977, R8, 5:15 to 6:30  
 POSTE PARISIEN, 961 kc. Like local, 6:00  
 11RO, 713, Rome, fair  
 STUTTGART, 574, fair about 6:30 p.m.  
 South Americans excellent 7:00 p.m.  
 MILAN, 814 kc., fair about 6:30 p.m.

**Reports from Ohio**

Official L.P.O. Shields (Roseville) reports the results of 2 DX sessions. On October 9th he heard Australians 5CK, 635 kc.; 4QG, 760 kc.; 2BL, 855 kc. On October 14th, he heard these again and also 2CO, 560 kc.; 3AR, 610 kc.; 3LO, 800 kc. On October 9th he also heard 4 Japs: JOHK, 770 kc.; JOIK, 830 kc.; JOFK, 850 kc.; and JOAK-1, 870 kc.

Rudolph Kure, of Cincinnati, states that CE106, Santiago, Chile, broadcasts until 1 a.m., E.S.T., on 1065 kc., with 500 watts.

**Report from Michigan**

Official L.P.O. Eck reports reception of 28 Japanese, 3 Chinese, 2 Hawaiian, and several South American stations. The following information about best hours of reception for Michigan listeners should be of interest.

"KGU, 750 kc., can be heard 3-3:40 a.m.; KGMB, 1320 kc., 2:30-3:30 a.m. Australians are good 5-7 a.m., and Japs 4:30-7:30 a.m. The New Zealand stations are heard usually an hour earlier than the

LANDESENDER BEROMÜNSTER  
 This Swiss station, operating on 556 kc. has returned to the air after a short absence during which the transmitter was altered to provide increased power of 100 kw.

Australians. Europeans have not been heard yet this year but am looking for them 4-7 p.m. and 1-4 a.m. South Americans are heard 6-9 p.m. OA4K, 1348 kc., heard well 6:30-7 p.m.; LS2, 7:30-8 p.m.; LR4, 8-9 p.m.; LR5, 8:15-8:45 p.m.; HHK heard on Friday 8:30-9:05 p.m., TGW, 3-5 a.m., Sunday. VOGY, 840 kc., heard Sunday, 2-3 a.m., E.S.T."

**Heard in Indiana**

Official L.P.O. Roberts reports: "Reception conditions fairly good and growing better. The best foreign station received is TGW, Guatemala City, on 565 kc., with 10 kw. This station is on the air every Sunday morning until 5 a.m., C.S.T., coming in usually at R7. Last Sunday morning, October 7th, for the first time in two years the Antipodes were coming through. At 4:25 a.m., C.S.T., 3YA, 720 kc., was heard, followed later by 4QG, 760 kc., and 2BL, 855 kc. The latter station was heard best but only for a few minutes before fading. During the latter part of September LS2, 1190 kc., was heard on two evenings around 7 p.m., C.S.T."

**Report from Illinois**

Official L.P.O. Everly has been going after the low power domestic stations and reports reception from:

Kc.	Call	Location	Watts
1500	KOTN	Pine Bluffs, Ark.	100
1500	WDNC	Durham, N. C.	100
1500	WHEF	Kosciusko, Miss.	100
1500	WMEX	Chelsea, Mass.	100
1420	WGFC	Albany, Ga.	100
1420	KXL	Portland, Ore.	100
1370	KRE	Berkeley, Calif.	100
1370	KERN	Bakersfield, Calif.	100
1370	WAGF	Dothan, Ala.	100
1260	KPAC	Port Arthur, Tex.	500
1210	KWTN	Waterown, S. D.	100
1210	WJIM	Lansing, Mich.	100
1200	KADA	Ada, Okla.	100
920	KVOD	Denver, Col.	500
740	KTRB	Modesto, Calif.	250
630	WPRO	Providence, R. I.	250
630	KCOV	Kelowna, B. C.	100
565	TGW	Guatemala	10,000

- (1) Very Strong—Sunday mornings, 7 a.m., C.S.T.
- (2) Heard Mon., Wed., and Fri. midnight, C.S.T.
- (3) Heard Sunday mornings to 4 a.m., C.S.T.

**Report from Texas**

Official L.P.O. Kimmons reports: "Due to the extreme hot, dry weather only the following new stations have been added to date: KADA, 1200 kc.; WHEF, 1500 kc.; WEED, 1420 kc.; and WNEW, 1250 kc. The monthly monitor tests were a complete flop. However, several new calls were heard, such as WCHS, USOC, WSGN, WWRL, and WOKO, but static was so bad that a report was not worth while. W2XR, 1550 kc., was also heard with good volume through interference from three Police stations. The following stations announced their monthly DX schedule: KFYZ, Bismarck, N. D., 550 kc., first Wednesday morning of each month 12-1 a.m., C.S.T. CFCN, 1030 kc., Calgary, Alberta, Canada, every Thursday night probably

(Courtesy—Official Listening Post Observer Tomlinson)

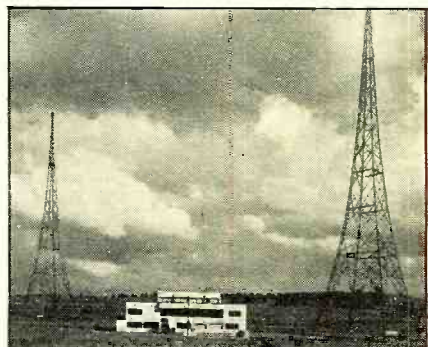

11 p.m. to 12 p.m., M.S.T.; WWL, New Orleans, La., is on each morning 1-3 a.m., C.S.T., except Monday morning, 850 kc. My New Zealand pal informs me that there is a movement on foot to construct a 50 kw. station in Suava, Fiji Islands to broadcast programs to Northern Australia, New Zealand, and Pacific Islands."

**Report from Minnesota**

Official L.P.O. Biss writes:

"Reception is excellent at this time of the year. The transpacifics come in almost as good as locals. On the morning of the 14th of October, 4BC, 4BH, 2UW, 2UE, 3HA, 2GB, 3UZ, 4RK, 2BL, 3LO, 4QG, 5CL, 3YA, 2FC, 3AR, and 2CO were all coming in. Other stations received that morning were: TGW, Guatemala; KGBU, Ketchikan; KGU, Honolulu; and CJIC, the new station in Sault Ste. Marie, 1010 kc.

W2XR, Long Island City, 1550 kc., was heard on October 8th with an afternoon program. The time heard was about 5:30 p.m., C.S.T."

**Wyoming Report**

Official L.P.O. Wood sends in an excellent report from which the following is quoted:

"I am inclosing list of the 15 best trans-Pacific stations heard at this post. They are listed in the order in which they come in. No. 1 has the most volume, No. 2 next best and so on. I am not listing any trans-Atlantic stations for the simple reason that they are not heard here. The Cubans and Puerto Ricans are heard here with fair signal strength.

"The Japs are coming in better this year than I have ever heard them. I have had several of the J's at full R9 volume several mornings the past week, at about 4 to 4:30 a.m. 2YA in Wellington is as consistent as ever and drops in almost every morning with a very good signal. On Sunday morning it is QRM'd considerably by TGW on 565 kc. which comes in with a terrific signal.

"Several mornings this past week I have had as many as 27 of the 36 J stations. Have had XMHA 600 kc., 600 watts, at Shanghai, China. Also heard 4ZP, 620 kc., 500 watts, at Invercargill, N. Z.

"The frequency checks from all over the country came in very good. KGU, Honolulu on 750 kc. drops in with a nice signal every morning."

Station	Location	Freq.	Remarks
1 TGW	Guatemala	565	Sunday 1:30 a.m. to 2:30 a.m.
2 2YA	N. Zealand	570	After 1:45 a.m.
3 JOIK	Japan	830	After 2:30 a.m.
4 JOBK2	Japan	1080	After 2:30 a.m.
5 4QG	Australia	760	After 2:30 a.m.
6 5CK	Australia	635	After 2:30 a.m.
7 2BL	Australia	855	After 2:30 a.m.
8 JOHK	Japan	830	After 2:30 a.m.
9 JOAK1	Japan	870	After 2:30 a.m.
10 JOFK	Japan	850	After 2:30 a.m.
11 2CO	Australia	560	After 2:30 a.m.
12 3YA	N. Zealand	720	After 1:45 a.m.
13 4RK	Australia	910	After 2:30 a.m.
14 XGOA	China	660	After 3:00 a.m.
15 KZRM	Manila, P. I.	618.5	After 3:00 a.m.

**California Report**

Official L.P.O. Winkley sends in an excellent list of distant stations logged in six weeks ending October 12th. These stations are listed below:

**Very Good (R8-R9, QSA4-QSA5)**

China: XGOA—660 kc.  
 Japan: JOAK-1—870 kc.; JOCK-1—810 kc.; JODK-1—610 kc.; JOFK—850 kc.; JOHK—770 kc.; JOIK—830 kc.; JOXK—980 kc.  
 Australia: 2BL—855 kc.  
 Alaska: KGBU—900 kc.

**Good (R5-R7, QSA3-QSA4)**

Japan: JOBK-1—750 kc.; JOBK-2—1085 kc.;

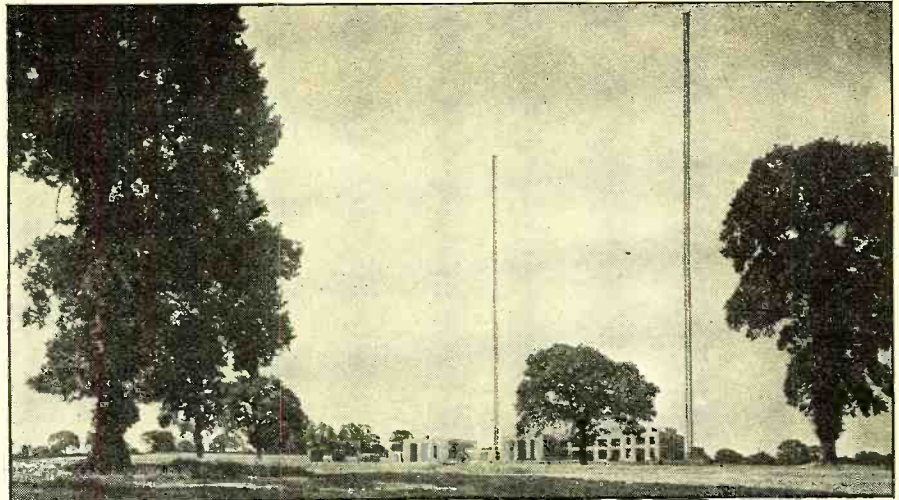

**THE POWERFUL NEW DROITWICH STATION, ENGLAND**

The 700-foot towers of the newest high power British station, and beneath the antenna the buildings which house the 150 kw. transmitter. This station now operates on 1500 meters and unfortunately is therefore outside the tuning range of most receivers used by U. S. fans.

JOCK-2—1175 kc.; JOGK—790 kc.; JOJK—710 kc.; JFAK—670 kc.;  
 New Zealand: 2YA—570 kc.; 3YA—720 kc.;  
 Hawaii: KGU—750 kc.  
 Buenos Aires: LS2—1190 kc.

**Fair (R4, QSA2)**

Japan: JONK—635 kc.; JOQK—920 kc.; JOJK—700 kc.; JOVK—680 kc.; JOUK—645 kc.  
 China: XOST—857 kc.  
 Australia: 4QG—760 kc.; 5CK—635 kc.; 4RK—910 kc.; 2UE—1025 kc.; 3AR—610 kc.; 5CL—730 kc.  
 Buenos Aires: LR2—910 kc.

**Poor (R3-R2, QSA2-QSA1)**

Japan: JORK—720 kc.; JOAK-2—590 kc.; JODK-2—900 kc.; JOTK—625 kc.  
 China: NGOD—978 kc.  
 Australia: 3LO—800 kc.  
 Cuba: CMK—725 kc.

**Heard (R1, QSA1)**

Japan: JFBK—720 kc.; JOFG—990 kc.; JODG—635 kc.; JOOK—960 kc.  
 Philippine Isles: KZRM—618 kc.

LR2 and LS2 were heard regularly in the evening. LS2 seems best from 6 to 7:30 p.m., P.S.T., and LR2 is best on Saturday nights from 8:30 to 9:30. WOCL, Jamestown, New York, 1210 kc., was heard. (This was excellent reception, considering that the power is only 50 watts.)

Observer Winkley asks that any DX listeners hearing station KTRB send reports to this station. All reports will be verified if a 3-cent U. S. stamp is enclosed. This station particularly desires reports from distant listeners, as they are making tests to determine the range this station covers.

Observer Winkley, by the way, has to date logged a total of 618 U. S. and foreign stations on an Atwater Kent, model 40, receiver. Among his prizes is a verification from XOST, a 500-watter in China, in which it is stated that he is the first U. S. listener to report this station.

**Report from Saskatchewan**

Official L.P.O. Ansell, Regina, sends in an excellent report on his reception:

"During the month of October, the reception of Australian and New Zealand stations was very consistent, with some of the Aussie class 'B' stations being received on a par with the class 'A' stations; the strength, readability and consistency of stations 4BC, 2UE, 3HA, 5CK, 2CO, 3LO, 2BL, 4QC, 2UW, and 3AR were especially noteworthy.

"After three weeks of persistency, I

finally was able to report to 5PI (power increased from 50 to 2000 watts, aerial). Another station which I have been unable to identify after three weeks' endeavor is coming in on 980 kc., which I believe to be that new Aussie—4AY, Aylbury, using 100 watts, aerial. Hope to get him yet. Reception chart as follows, all hours a.m., M.S.T.:

Call	Kc.	R	QSA	Best Time
4BC	1145	4-7	2-5	3:00-4:30 a.m.
2YA	570	5-7	2-4	2:00-4:00 a.m.
3LO	800	5-7	2-4	3:30-5:00 a.m.
2BL	855	5-7	3-4	3:00-5:00 a.m.
2UE	1025	4-7	2-4	3:00-5:00 a.m.
3HA	1010	4-8	3-5	4:00-5:30 a.m.
2GB	950	5-6	2-3	3:00-5:00 a.m.
4RK	910	5-6	2-3	3:00-5:00 a.m.
3AR	610	5-6	3-4	3:30-5:00 a.m.
2CO	560	5-7	3-4	3:00-5:00 a.m.
4QG	760	5-7	3-4	3:00-5:00 a.m.
2OW	1125	4-6	2-4	3:00-5:00 a.m.
3OZ	930	4-5	2-3	3:30-5:00 a.m.
5PI	1040	4-6	2-3	4:00-5:00 a.m.
3YA	720	5-6	2-4	2:30-4:00 a.m.
5CK	635	5-6	3-4	3:30-5:00 a.m.
5CL	730	4-5	2-3	4:00-5:00 a.m.
4BH	1380	5-6	3-4	3:30-5:00 a.m.
CMQ	840	8-9	4-5	1:00-2:00 a.m.
TGW	565	5-7	2-4	1:30-3:00 a.m.
XEAF	1010	7-8	4-5	2:00-3:00 a.m.
JOCK-1	810	7	4	4:00-5:30 a.m.
JOCK-2	1175	5-7	3-4	Variable
JOAK-1	870	4-6	2-4	4:00-5:30 a.m.
JOAK-2	590	5-7	3-4	Variable
JOFK	850	7	4	4:00-5:30 a.m.
JOGK	790	6-7	2-4	4:00-5:30 a.m.
JOBK-1	750	7	4	4:00-5:30 a.m.
JOIK	830	6	4	4:00-5:30 a.m.
JOHF	770	4-7	3	4:00-5:30 a.m.
JOFG	990	4-5	2-3	4:30-5:30 a.m.
JOLK	680	3-5	2-3	4:45-5:30 a.m.
JOJK	710	5	3	4:00-5:30 a.m.
JORK	720	4-6	3-4	4:30-5:30 a.m.
JOSK	735	5-6	3-4	4:00-5:30 a.m.
JOBG	970	3-5	2-3	4:30-5:30 a.m.
JOAG	930	5	3	4:30-5:00 a.m.
JOOK	920	5	3	4:30-5:00 a.m.
JOJK	700	5	3	4:00-5:00 a.m.
JOJK	780	4-5	3	4:30-5:00 a.m.

**Report from Sweden**

John S. Bohm, Official L.P.O. for Sweden sends in the following report which should be of interest to Central European listeners:

"For this season the U. S. stations have not yet been very well received, except a couple of times when the usual east coast stations were coming over with good volume. On September 8th at 4:30-5:30 a.m., Middle European Time, WCAU, 1170 kc.; WPG, 1100 kc.; WJZ, 760 kc. and WIOD, 130 kc. were heard R7-R8. The 1000 watter WIOD in Miami, Florida, was the best one for that morning. Also KSL, 1130 kc., Salt Lake City, was audible at the same time. On October 6th at 5:15 a.m., I tuned for U. S. Stations but I heard

(Continued on page 447)

# BROADCAST STATIONS IN THE U. S.

(Revised; by Frequency, Wavelength and Call Letters)

- 550 kc., 545.1 m.  
KFOO, KFYR, KOAC, KSD, WDEV,  
WGR, WKRC.
- 560 kc., 535.4 m.  
KFDL, KLZ, KTAB, KWTO, WFI, WIND,  
WLIT, WNOX, WQAM.
- 570 kc., 526.0 m.  
KGGO, KMTR, KVI, WKBN, WMCA,  
WNAJ, WOSU, WSYR, WSYU, WWNC.
- 580 kc., 516.9 m.  
KMI, KSAC, WCHS, WDBO, WIBW,  
WTAG.
- 590 kc., 508.2 m.  
KHQ, WEEI, WKZO, WOW.
- 600 kc., 499.7 m.  
KFSD, WCAC, WCAO, WICC, WMT,  
WREC.
- 610 kc., 491.5 m.  
KFER, WDAF, WIP, WJAY.
- 620 kc., 483.6 m.  
KGV, KTAR, WFLA, WSUN, WHJB,  
WLBZ, WTMJ.
- 630 kc., 475.9 m.  
KFRU, KGFY, WGBF, WMAL, WOS.
- 640 kc., 468.5 m.  
KFI, WAIU, WOL.
- 650 kc., 461.3 m.  
KPCB, WSM.
- 660 kc., 454.3 m.  
WAAW, WFAF.
- 670 kc., 447.5 m.  
WMAQ.
- 680 kc., 440.9 m.  
KFEQ, KPO, WPTF.
- 690 kc., 434.5 m.  
*(Reserved for Canadian Stations)*
- 700 kc., 428.3 m.  
WLW.
- 710 kc., 422.3 m.  
KMPC, WOR.
- 720 kc., 416.4 m.  
WGN.
- 730 kc., 410.7 m.  
*(Reserved for Canadian Stations)*
- 740 kc., 405.2 m.  
KMMJ, KTRB, WHEB, WSB.
- 750 kc., 399.8 m.  
KGU, WJR.
- 760 kc., 394.5 m.  
KXA, WEW, WJZ.
- 770 kc., 389.4 m.  
KFAB, WBBM.
- 780 kc., 384.4 m.  
KELW, KFDY, KFQD, KTM, WEAN,  
WMC, WTAR.
- 790 kc., 379.5 m.  
KGO, WGY.
- 800 kc., 374.8 m.  
WBAP, WFAA, WTBO.
- 810 kc., 370.1 m.  
WCCO, WNYC.
- 820 kc., 365.6 m.  
WHAS.
- 830 kc., 361.2 m.  
KOA, WEEU, WHDH, WRUF.
- 840 kc., 356.9 m.  
*(Reserved for Canadian Stations)*
- 850 kc., 352.7 m.  
KIEV, KWKH, WWL.
- 860 kc., 348.6 m.  
WABC, WBOQ, WHB.
- 870 kc., 344.6 m.  
WENR, WLS.
- 880 kc., 340.7 m.  
KFKA, KLX, KPOF, WCOC, WGBI,  
WQAN, WSUI.
- 890 kc., 336.9 m.  
KSRK, KFNF, KSEI, KUSD, WBAA,  
WGST, WILL, WJAR, WMMN.
- 900 kc., 333.1 m.  
KGBU, KHJ, WBEN, WJAX, WKY,  
WLBL.
- 910 kc., 329.5 m.  
*(Reserved for Canadian Stations)*
- 920 kc., 325.9 m.  
KFEL, KOMO, KPRC, KVOD, WAAF,  
WBSO, WWJ.
- 930 kc., 322.4 m.  
KGBZ, KMA, KROW, WBRC, WDBJ.
- 940 kc., 319.0 m.  
KGIN, WAAT, WAVE, WCSH, WDAY,  
WHA.
- 950 kc., 315.6 m.  
KFWB, KGH, KMBC, WRC.
- 960 kc., 312.3 m.  
*(Reserved for Canadian Stations)*
- 970 kc., 309.1 m.  
KJR, WCFL, WIBG.
- 980 kc., 305.9 m.  
KDKA.
- 990 kc., 302.8 m.  
WBZ, WBZA, WJEM.
- 1000 kc., 299.8 m.  
KFVD, WHO, WOC, WORK.
- 1010 kc., 296.9 m.  
KGGF, KQW, WHN, WIS, WNAD.
- 1020 kc., 293.9 m.  
KYW, WRAX.
- 1030 kc., 291.1 m.  
*(Reserved for Canadian Stations)*
- 1040 kc., 288.3 m.  
KRLD, KTHS, WESG, WKAR.
- 1050 kc., 285.5 m.  
KFBI, KNX.
- 1060 kc., 282.8 m.  
KWJJ, WBAL, WJAG, WTIC.
- 1070 kc., 280.2 m.  
KJBS, WCAZ, WDW, WTAM.
- 1080 kc., 277.6 m.  
WBT, WCB, WMBL.
- 1090 kc., 275.1 m.  
KMOX.
- 1100 kc., 272.6 m.  
KGD, WLWL, WPG.
- 1110 kc., 270.1 m.  
KSOO, WRVA.
- 1120 kc., 267.7 m.  
KFIO, KFSG, KRKD, KRSC, WDEL,  
WISN, WTAW.
- 1130 kc., 265.3 m.  
KSL, WJJD, WOV.
- 1140 kc., 263.0 m.  
KVOO, WAPI.
- 1150 kc., 260.7 m.  
WHAM.
- 1160 kc., 258.5 m.  
WOWO, WWVA.
- 1170 kc., 256.3 m.  
WCAU.
- 1180 kc., 254.1 m.  
KEX, KOB, WDG, WINS, WMAZ.
- 1190 kc., 252.0 m.  
WATR, WQAI, WSAZ.
- 1200 kc., 249.9 m.  
KADA, KBTM, KFJB, KFND, KFXJ,  
KGD, KGF, KGF, KGH, KGO,  
KMLB, KOOS, KSUN, KVO, KWG,  
WAB, WBBZ, WBBS, WBN, WCAT,  
WCAX, WCLO, WFAM, WFBE, WHBC,  
WHBY, WIBX, WIL, WIBC, WJBL,  
WJWB, WKBO, WKJC, WLV, WMP,  
WNB, WORC, WPHR, WRBL, WSIX,  
WVAE.
- 1210 kc., 247.8 m.  
KASA, KDLR, KFJI, KFOR, KFPW,  
KFVS, KFXM, KGY, KIEM, KPPC,  
KWEA, KWTV, KWTN, WALR, WBAX,  
WBEL, WBRB, WCBS, WCRW, WBO,  
WEDC, WFAS, WGBB, WGCN, WGN,  
WHBF, WHBU, WIBU, WJBY, WJEL,  
WJW, WKFI, WKOK, WMBG,  
WOC, WOP, WPRO, WQDX, WSBC,  
WSEN, WSOC, WTAX.
- 1220 kc., 245.8 m.  
KFKU, KTW, KWSC, WCAD, WCAE,  
WDAE, WREN.
- 1230 kc., 243.8 m.  
KGBX, KGGM, KYA, WFBM, WNAC.
- 1240 kc., 241.8 m.  
KGC, KLP, KTAT, KTFI, WKAQ,  
WXYZ.
- 1250 kc., 239.8 m.  
KFOX, WCAL, WDSU, WGCP, WHBI,  
WNEW, WTCN.
- 1260 kc., 238.0 m.  
KOIL, KPAC, KRGV, KUOA, WLWB,  
WNBX, WTC.
- 1270 kc., 236.1 m.  
KGA, KOL, KVOR, KWLC, WASH,  
WFB, WJDX, WOOD.
- 1280 kc., 234.2 m.  
KFBB, WCAM, WCAP, WDOD, WIBA,  
WRR, WTNJ.
- 1290 kc., 232.4 m.  
KDYL, KLCN, KTSA, WEBC, WJAS,  
WNBZ, WNEL.
- 1300 kc., 230.6 m.  
KALE, KFAC, KFH, KFJR, WBBR,  
WEVD, WFAB, WFBC, WHAZ, WIOD,  
WMAF.
- 1310 kc., 228.9 m.  
KCRJ, KFBK, KFPL, KFPM, KFRR,  
KFYO, KGBX, KGCC, KGEZ, KGF,  
KIT, KMED, KRMD, KTSM, KNRO,  
WAML, WBO, WBO, WBR, WCLS,  
WDAH, WBR, WEX, WFBG, WFD,  
WGH, WJAC, WLB, WLNH, WOL,  
WRAW, WROL, WSA, WSGN, WSJS,  
WTEL, WJTS, WTRC.
- 1320 kc., 227.1 m.  
KGF, KGMB, KID, KSO, WADC,  
WSMB.
- 1330 kc., 225.4 m.  
KGB, KMO, KSCJ, KTRH, WDR, WSAI,  
WTAQ.
- 1340 kc., 233.7 m.  
KFPY, KGDY, KGNO, WCOA, WFEA,  
WSPD.
- 1350 kc., 222.1 m.  
KIDO, KWK, WAWZ, WBNX, WEHC.
- 1360 kc., 220.4 m.  
KGER, KGR, WCSC, WFBL, WGES,  
WQBC, WSBT.
- 1370 kc., 218.8 m.  
KCR, KERN, KFGO, KFJM, KFJZ,  
KGR, KGF, KGL, KIC, KIC,  
KLUF, KMAC, KONO, KRE, KRK,  
KSLM, KUJ, KWKC, KWYO, WAG,  
WBTM, WCBM, WDS, WGL, WGL,  
WHBD, WHBO, WHDF, WIBM, WIT,  
WLH, WBRN, WFFB, WQDM, WRAK,  
WRDO, WJJB, WSVS.
- 1380 kc., 217.3 m.  
KOH, KQV, WALA, WKBH, WSMK.
- 1390 kc., 215.7 m.  
KLRA, KOY, WHK.
- 1400 kc., 214.2 m.  
KLO, KTUL, WARD, WBBC, WKBF,  
WLTH, WVFW.
- 1410 kc., 212.6 m.  
KGRS, WAAB, WBCM, WDAG, WHBL,  
WHIS, WRBX, WROK, WSFA.
- 1420 kc., 211.1 m.  
KABC, KBPS, KCNC, KFIZ, KGF,  
KGGC, KGIW, KGIX, KICK, KIDW,  
KORE, KUMA, KWCR, KXL, WACO,  
WAGM, WAMC, WAZL, WEED, WEHS,  
WELL, WGPC, WHDL, WHFC, WILM,  
WJBO, WJMS, WKBL, WLAP, WLBF,  
WLEU, WMAS, WMBC, WMBH, WNRA,  
WPAD, WSPA.
- 1430 kc., 209.7 m.  
KECA, KGNF, WBNS, WHEC, WHP,  
WNR, WOKO.
- 1440 kc., 208.2 m.  
KDFN, KLS, KXYZ, WBIG, WCB,  
WMBD, WSA, WTAD.
- 1450 kc., 206.9 m.  
KTBS, WGAR, WHOM, WSAR, WTFI.
- 1460 kc., 205.4 m.  
KSTP, JISV.
- 1470 kc., 204.0 m.  
KGA, WLAC.
- 1480 kc., 202.6 m.  
KOMA, WKBW.
- 1490 kc., 201.2 m.  
WCKY.
- 1500 kc., 199.9 m.  
KDB, KFI, KGF, KGB, KGV,  
KNOW, KOTN, KPM, KPO, KREG, KKO,  
WCNW, WDC, WGA, WHEF, WKB,  
WKB, WKB, WKB, WKEU, WMBQ,  
WMBX, WMBF, WOP, WPN, WRDW,  
WRGA, WSYB, WWRL, WWSW.



# Working with one hand tied behind?

How often have you spent hours, perhaps days, trying to locate the cause of oscillation in a radio receiver? You checked the screen bypass capacitor—tried to lower the screen potential—removed the tuning capacitor and cleaned the wiping contacts, installed pig tails, bonded the shielding, and tried to realign the tuning stages, but still the radio oscillated and refused to operate satisfactorily.

Then, you probably packed up the receiver and carried it to a jobber whose service department may have repeated your "cut and try" methods in an effort to locate the trouble. Finally, a procedure of substitution of parts was tried as a last resort, and it was found that the trouble cleared up when one of the electrolytic filter capacitors was replaced.

What was wrong with the original electrolytic capacitor? You probably assumed that it had "opened up" or lost some of its capacity, and you reasoned that you could have saved yourself a lot of lost time and trouble if you had been able to check the electrolytic capacitor, but you did not have facilities for measuring the capacity of electrolytic capacitors.

In other words, you did not have a Supreme Model 333 DeLuxe Analyzer which is the first and only analyzer to offer facilities to measure electrolytic, as well as paper capacitors, in six ranges from 0.001 to 12.5 mfd.

Under today's service conditions, if you are working with an analyzer that does not give you this facility you are slowing up your own skill, shrinking your own income—it's like working with one hand tied behind you. And when you pay as much as \$40.00 for an analyzer, you are entitled to a complete electrolytic capacitor tester, as well as a complete analyzer. The Model 333 DeLuxe Analyzer is the only way to get it.

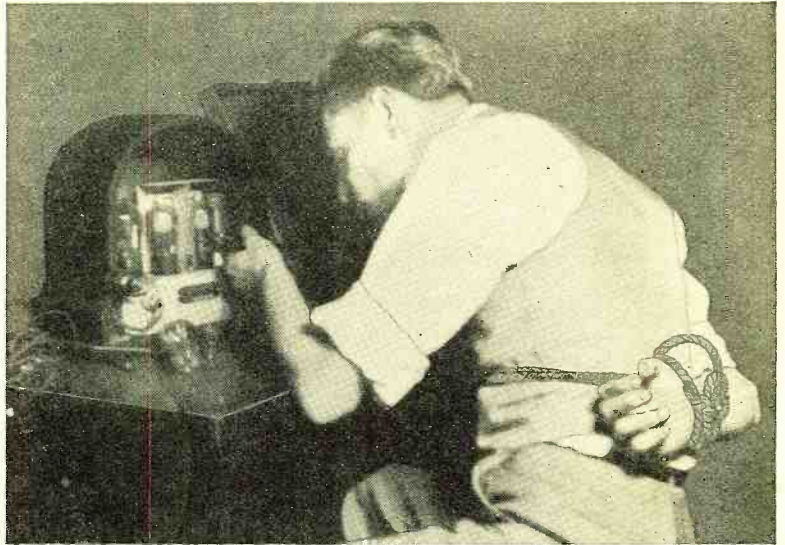

Ask your jobber to show you this supremely fine and complete, compact radio laboratory. Includes such additional exclusive features as circuit for compensating effects of temperature and other variations of the full wave rectifier unit, free reference point system of analysis, Supreme's 5" fan-shape, full-vision meter. Meanwhile, send coupon for detailed technical data and complete catalog on Supreme instruments.

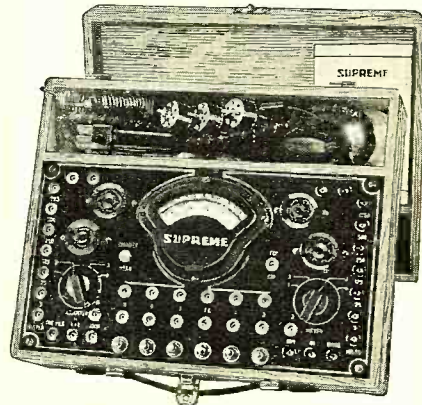

## SUPREME 333 DELUXE RADIO ANALYZER

Dealers Net Cash  
Wholesale Price

**\$39.95**

Supreme 333 Standard  
Radio Analyzer

**\$29.95**

# Ends the mystery of certain noisy tubes

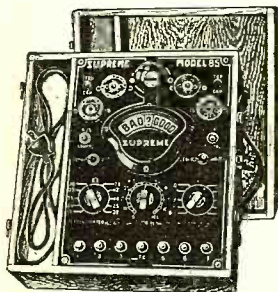

Dealers Net Cash  
Wholesale Price.  
Available also in  
modernistic Walnut  
upright Counter Model.

**\$39.95**

Supreme 35 Tube Tester **\$29.95**

Supreme Neonized Tube Tester Model 85-P will soon pay for itself in the additional tube sales on faulty tubes that are now passing the simple "good" test on your ordinary tester. Gives a double check. Flashes a vivid neon signal between the elements where short circuits and leakages are hiding out. Ends the mystery of certain noisy tubes that have been worrying both you and your customer. The authentic, accepted, original Neonized tester. Get a demonstration from your jobber.

## SUPREME NEONIZED TUBE TESTER 85-P

SUPREME INSTRUMENT CORP.,  
510 Supreme Bldg., Greenwood, Miss.

Please send complete detailed Catalog 1935 Supreme Models.

Name .....

Address .....

City ..... State .....

Jobber Preference .....



GRAHAM McNAMEE  
GRACE MOORE



ROSE BAMPTON  
WALTER O'KEEFE



Chatty Bits  
on Radio  
Personalities

## BACKSTAGE *in* BROADCASTING

**ED WYNN** has returned to his Tuesday night NBC program spot with the welcome assertion that he will use his tag-line of "So-o-o-o-o-o!" less frequently this season. The Fire Chief, once more sponsored by the Texas Company, claimed that it's the public and not the performer who makes tag-lines. "If any phrase of mine catches the public fancy and becomes popular of its own accord," he says, "that's another thing. But I don't intend to try to force the recognition of a phrase." In the writer's opinion, an oft-repeated tag-line can make the brightest of programs seem hackneyed and dull. Graham McNamee is back as Wynn's straight man, but Eddie Duchin, the young dance maestro, occupies the rostrum instead of Don Voorhees.

**ONE** of the radio highlights of broadcasting's early days was the Atwater Kent Hour, which set a standard for high type talent that is still remembered and praised. That Atwater Kent Manufacturing Company has joined the growing list of radio manufacturers sponsoring broadcast programs by returning to the air via CBS with a Monday night offering. Joseph Pasternak handles the baton and a new guest star of wide fame is presented

### Samuel Kaufman

each week. Grace Moore, comely prima donna, had the distinction of being the first guest star of the new series.

**ROSE BAMPTON**, young contralto of the Metropolitan Opera Company, is featured on the new "Songs You Love" program heard Saturdays over NBC under the sponsorship of Smith Brothers. Nathaniel Shilkret and his orchestra and Billy Hillpot and Scrappy Lambert, vocalists, accompany Miss Bampton. The series is semi-classical, with the interspersing of an occasional popular number.

**WITH** repeated talkie successes placing his name high in the amusement world, Bing Crosby is back on the air as star of a Tuesday CBS feature which also includes the Boswell Sisters—Connie, Martha and Vet—and George Stoll's Orchestra. Bing remains the most successful radio performer in the cinema world, his pictures grossing box-office receipts which talkie stars of long standing envy.

**WALTER O'KEEFE**, the stage star who bobs up on the radio every now and then, has come to CBS with a new

program which shapes up as a humdinger. The new feature, heard Tuesdays, includes Ted Husing, noted sports announcer; Annette Hanshaw, cute erstwhile feature of the NBC Show Boat program, and Glen Gray's Casa Loma Orchestra. Presented by the same sponsor as Glen Gray's series of last season, the program has been named "Camel Caravan."

**IT** took a long time for "America's Sweetheart" to join the ranks of regularly heard radio entertainers. A tremendous group of fans from coast to coast awaited the starring of Mary Pickford on a radio series. The screen star is presented Wednesdays over NBC on the Standard Brands program which, until recently, featured Jack Pearl. Miss Pickford and a supporting cast broadcast condensed versions of popular plays from the West Coast NBC studios.

**JANE FROMAN**, one of the most beautiful girls in the radio ranks, is the star of the new Sunday night series of Pontiac programs on NBC. She is supported by a prominent cast of entertainers, including Don McNeil, Western comedian, Frank Black's new concert dance orchestra and Emile Cote's modern choir. Blatant



ED. WYNN



JOSEPH PASTERNAK



CONNIE BOSWELL



NAT. SHILKRET



MARY PICKFORD

brasses are lacking in Black's new instrumental aggregation. The lone exception is a muted trumpet. His 43-piece unit consists chiefly of strings and woodwinds. The program's novel make-up sets it forward as one of the most distinctive offerings of the season.

COUNTESS OLGA ALBANI, soprano, and Charles Previn's Orchestra are co-featured in the new Realsilk series Sunday nights on NBC. Countess Albani's extensive radio background has earned her a tremendous audience.

IT is surprising that the old-time minstrel show idea is not used more widely on the air. There have been a few programs styled after the old-fashioned blackface song-and-comedy shows and, on the whole, they were all pretty good and air audiences took to them. The Mollé Company has recognized a demand for more of this type of entertainment and is sponsoring Al Bernard and Paul Dumont as end men in the Mollé Minstrel Show heard over NBC Mondays, Thursdays and Fridays. The surrounding cast includes Milt Rettenberg's Orchestra, and a male quartet known as the Melodeers. Mario Cozzi, baritone, is assigned a special program spot on the Friday broadcasts only.

JANE FROMAN



and other big radio stars  
Urge you to buy radio tubes  
**ONLY IN SEALED CARTONS**

*Your sure protection against buying old tubes disguised as new*



**HUNDREDS** of thousands have their radio pleasure destroyed by old radio tubes disguised and sold as new. Dishonest dealers slip worn-out tubes into new-looking "open-flap" cartons. This RCA-Sealed Carton stops that... guarantees your getting new, untampered-with RCA Micro-Sensitive Radio Tubes. While still in the carton the tube can be tested, but carton *must be wholly destroyed* before tube can be removed.

Remember this: only tubes in these sealed cartons bearing the RCA monogram are guaranteed by the RCA Radiotron Co., Inc. to give you these 5 big improvements: (1) *Quicker Start.* (2) *Quieter Operation.* (3) *Uniform Volume.* (4) *Uniform Performance.* (5) *Sealed Carton Protection.*



**RCA** Cunnigham **RADIO TUBES** Radiotron

**LOOK FOR THIS SIGN.** It identifies a dealer selected by RCA.

**NEW LOW LIST PRICES**

**On Parts for Modernizing Your Analyzer**

- 907 WLCA Famous Na-Ald Small 7-Prong Analyzer Latch Lock Plug with Twin C. G. Handle and five feet of 8-wire cable attached. Used by Weston, Hickok, etc. 907 WLCA as described above. List price. \$2.50
- 974DSA, 975DSA, 976DSA and 977DSA 4, 5, 6 and 7-prong Associate Adapters. List price each adapter. . . . .75
- 907 WLCA KIT. Complete kit of above plug with cable and four associate adapters. List price of kit. . . . . \$5.50
- New Improved Wearproof Composite Sockets.** Have new silver plated twin pressure laminated contacts for standing up under all kinds of use and abuse. Individual contacts nested in molded pockets for utmost dependability of contact and insulation.
- 456E Composite 4-5-6 socket. Fits 1 3-8" hole. List price. . . . . \$50
- 477E Double 7 (lg 7-sm 7) socket. Fits 1 3-8" hole. List price. . . . . \$50
- New Miniature Molded Jacks, Plugs and Leads**
- 101J Phone-Tip Jacks. Mounts in 3/4" hole. Unique clip insures dependable contact. Complete with 10 marking tabs and hardware. Black molded top. List price each. . . . .15
- 100J Side-Pressure Jack. Mounts in 3/4" hole. Uses new Alden Silver plated BERYLLIUM COPPER "S" plug points. (See p. 242, Oct. Radio News)
- 100J (Black) 100JR (Red) Jacks. Each. . . . .15
- 102JR Circuit Opening Jack. Mounts in 3/4" hole. Enables both current and voltage tests to be made with only one jack in each circuit. Dependable solid silver contact. Molded red top. List price each. . . . .35
- 111D Double Circuit Plug with molded handle to fit 102JR above. Reliable silver contacts. List. . . . .40
- 111DL Current Plug Leads completely wired with leads and two molded plug terminals. For reading current in 102JR jacks. List price each. . . . . \$1.00
- 112SL Black Jumper Lead wired with S points in black molded handles. Fine for point to point. List price. . . . .50
- 112SLR Same as 112SL, but all in red. List price. . . . .50
- 110TL Alden De Luxe Test Leads. List. \$1.90 per pair.
- 91T Molded Cap Control Grid Lead 10" long with phone-tip terminal. Contacts all tube caps. List price each. . . . .25

**PRECISION WOUND S. W. COILS**

All coils listed below are boxed with diagrams and directions and use 140 mmf. size condenser.

Each of the following three S.W. Coil Sets (13 to 200 meters) have 3 coils wound on the special Na-Ald Processed Synthetic Molded Forms and the fourth coil—13 to 31 meters—is wound on VICTRON "AA" the ultimate in low-loss insulation. Precision wound coils with convenient color-coded grip-rim for easy insertion and removal from socket.

- 704SWS 4-pin Coils. . . . . List \$2.00 set
- 705SWS 5-pin Coils. . . . . List \$2.50 set
- 706SWS 6-pin Coils. . . . . List \$3.50 set
- Set of 2 Coils for 100-550 meters. . . . . List \$1.50 set
- 704BCS 4-pin Coils. . . . . List \$1.50 set
- 705BCS 5-pin Coils. . . . . List \$1.75 set
- 706BCS 6-pin Coils. . . . . List \$2.00 set
- Band Spreading Coils with ceramic padding condenser mounted on each coil. Simplifies tuning. Spreads stations.
- 705WB-20-80-150 m. Amateur Coils. . . . .
- 705SWS-19-25-31-49 m. S.W. B.C. Coils. List price \$4.00 per set, \$1.00 per coil.
- Long Wave Coils for S.W. Sets using 140 mmf. and 4-prong Coils.
- 704LW1 450-960 meters. . . . . List \$1.00
- 704LW2 940-2000 meters. . . . . List \$1.00
- 704LWS Set of 2 Coils. . . . . List \$2.00 set

NA-Ald items are widely stocked—try your regular supplier—if he hasn't them and does not care to get the genuine Na-Ald products order direct from us. Send us the name of your supplier for NEW 16-PAGE CATALOG NOW READY. Shows new test equipment, kits, accessories, coils, condensers, dials, knobs, jacks, plugs, cases, VICTRON S.W. parts of all kinds, etc.

**ALDEN PRODUCTS CO.**  
Dept. RN-1 715 Centre St.  
BROCKTON, MASS.

**"Bruno" NEW AND IMPROVED RIBBON MICROPHONE**

Excellent fidelity characteristics  
—Free from background noise  
—directional—not affected by temperature changes or humidity—completely assembled with matching transformers and laboratory tested—frequency response from 60 to 10,000 C.P.S.

Dealers Price. . . . . **\$15.00**

**NEW! A. C. OPERATED PRE-AMPLIFIER**

with an 80 D.B. gain—completely built in one unit 7" x 14" x 5" with a hum level below audibility—weight 12 lbs.

Dealers Write for Bulletin Series "A" Giving Full Information

**Bruno Laboratories** 24 West 22nd St. New York, N. Y.

**LEARN RADIO**  
200 Graduates Placed in the Last Three Years

At the oldest, largest and best equipped privately owned radio operating school in the East. Western Electric and RCA tube transmitters; 200 licensed graduates placed in past three years in broadcasting, shipping, police radio, aviation, service work, etc. Course prepares for all U.S. Government Telegraph and Telephone licenses. Send for 40-page catalog. Investigate. New classes every six weeks from Sept. 10th. Open all year around.

**MASS. RADIO SCHOOL** 18 Boylston St., BOSTON  
R. F. Tron, Treas.—EST. 1899—G. R. Entwistle, Pres.  
One of America's leading Radio Schools



**WITH THE EXPERIMENTERS**  
WILLIAM C. DORF

**Renewing the Appearance of Bakelite and Hard-rubber Parts**

While experimenting, one of our men noticed that some of the binding posts on an old panel had taken on a brand new appearance and on investigating discovered that some vaseline had been accidentally rubbed on them and was the answer for their new shiny look. We now use vaseline to brighten old bakelite or hard rubber panels and it is also effective for shining up dull and worn equipment. We have tried other preparations but find the vaseline to give best results.

PRECISION RADIO LABS.,  
Chicago, Ill.

**A Handy Workshop for the Experimenter**

The new General Electric workshop shown in the accompanying photograph is a compact combination machine designed to do all sorts of operations in wood and the softer metals. While it is primarily intended for the home workshop it can be applied to a great many professional uses.

The machine is equipped with a hollow-ground smooth-cutting circular saw and a full size industrial type chuck of half inch capacity.

A few of the many operations this workshop can perform include: sawing wood—cross-cut or rip, turning brass and aluminum, cutting rabbets and grooves, grinding and buffing, drilling both wood and metal, scroll work on wood and metals, and wood

turning with a limit of nine inches diameter for face-plate work.

The machine is made with a unique clamping arrangement which makes it possible to change from one attachment to another in a few seconds. The workshop including all its attachments is packed in a box about a foot square by 38 inches in length.

The motor which is especially designed for the workshop is ball bearing equipped and has a 3/4 inch shaft stepped down to 5/8 inch at the bearings.

**An Inexpensive Output Indicator**

Lining up a receiver for maximum output is usually accomplished by the serviceman with the aid of a modulated oscillator and an output meter.

If an output meter is not available con-

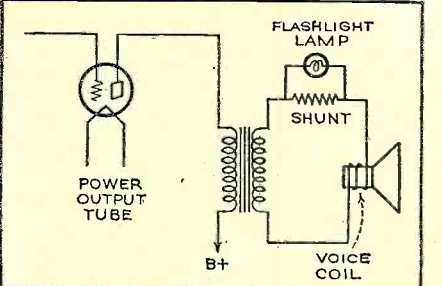

nect a Mazda flash-light bulb in series with the speaker voice coil, shunted with

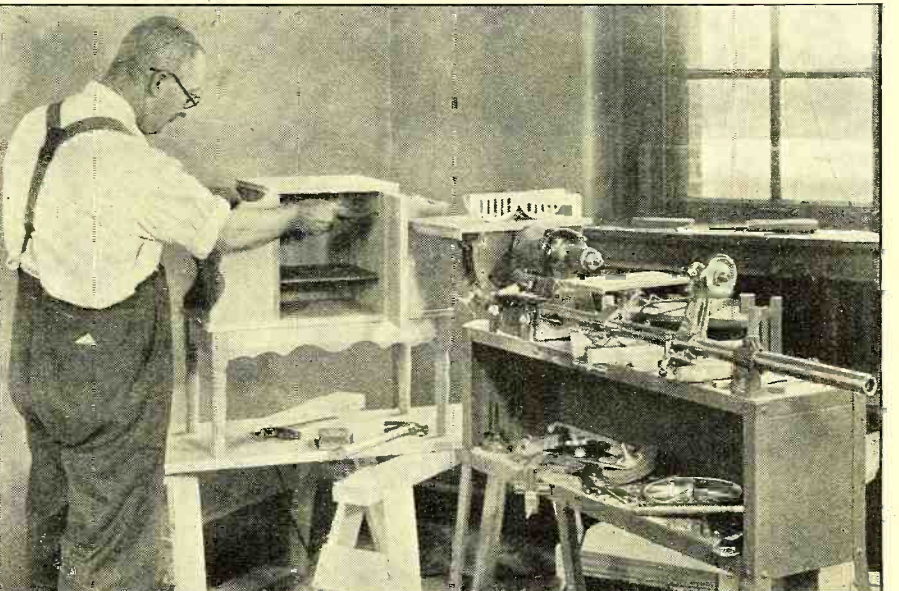

low resistance and experimenters will find that it makes an excellent indicator of the output power. The eye is very sensitive to changes in brightness and the characteristic of an electric bulb is such, as to show a large change in light with a comparatively small change in current, both factors therefore helping to make this visual method satisfactory. Start with the volume control at a low level, otherwise the bulb will burn out. If this should happen, however, it will not be as expensive as wrecking a thermo-couple or a rectifier type instrument.

WALTHER RICHTER,  
Milwaukee, Wis.

**Radio News "Blueprints"**

THE following sets of "blueprints," including full-scale picture wiring diagrams, chassis specifications, drilling layouts, etc., are available at 25c per set.

THE "DRAGNET"—A 2-tube, 2-volt battery operated short-wave receiver providing 1 stage untuned r.f. (34 tube) and a dual purpose type 19 tube which serves as regenerative detector and 1 audio stage. Described in August, 1934, issue.

THE "SCOUT'S OWN"—A simple, modern 1-tube (type 30) regenerative receiver for short-waves. Described in the September, 1934, issue.

THE "SKYSCRAPER"—A 3-tube fully shielded, short-wave receiver using latest 6-volt tubes. Includes 6D6 tuned r.f. stage, 6C6 regenerative detector and 41 pentode audio stage and operates from a.c. line or batteries. Features single dial band-spread tuning with standard plug-in coils. Described in November and December, 1934, issues of RADIO NEWS.

Address all orders to: RADIO NEWS, Blueprint Department, 461 Eighth Ave., New York City.

**Fuse the Power Transformer**

An accidental short-circuit in the secondary side of the power transformer, in nine out of ten cases spells destruction for the transformer and this could be easily avoided by placing a single fuse in the primary side of the unit as shown in the drawing.

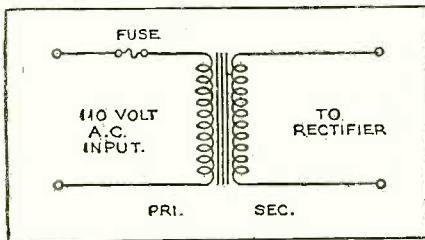

The fuse can be of the ordinary cartridge plug type with a rating of about 2 or 3 amperes to take care of the standard radio receiving set and power amplifier.

WILLIAM PELLY,  
Los Angeles, Cal.

**To Overcome Howling**

To eliminate that annoying warming-up howl so often encountered with the old style radio receiving sets, which employ the slow-heating type 27 as a detector and the type 26 tube in the r.f. stages, I offer the suggestions of replacing the detector tube with the new quick-heater type and if this does not help try reversing the leads to the audio transformer.

NOEL CURRY.

*Master* **INTERCHANGEABILITY**

TRIPLETT interchangeable Master Units make possible different combinations of test equipment... a complete tester for every purpose. Units may be used as furnished, or placed in convenient portable cases holding one, two, three or four units. A counter case is furnished for the tube tester unit.

Triplett instruments are recognized standards. They are reliably accurate and dependable in performance. These new Master Units typify Triplett adaptability to meet every servicing requirement.

by **TRIPLETT**

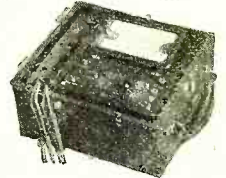

One Unit Portable Case No. 1201  
Takes Any Master Line Unit.  
Case only—Dealer's net price \$4.00

**Triplett Master Test Set No. 1205**

- includes
- VOLT-OHM-MILLIAMMETER No. 1200
- FREE-POINT TESTER No. 1220
- ALL-WAVE SIGNAL GENERATOR No. 1230
- TUBE TESTER No. 1210

Complete in Portable Case No. 1204

Dealer's net price

**\$71.33**

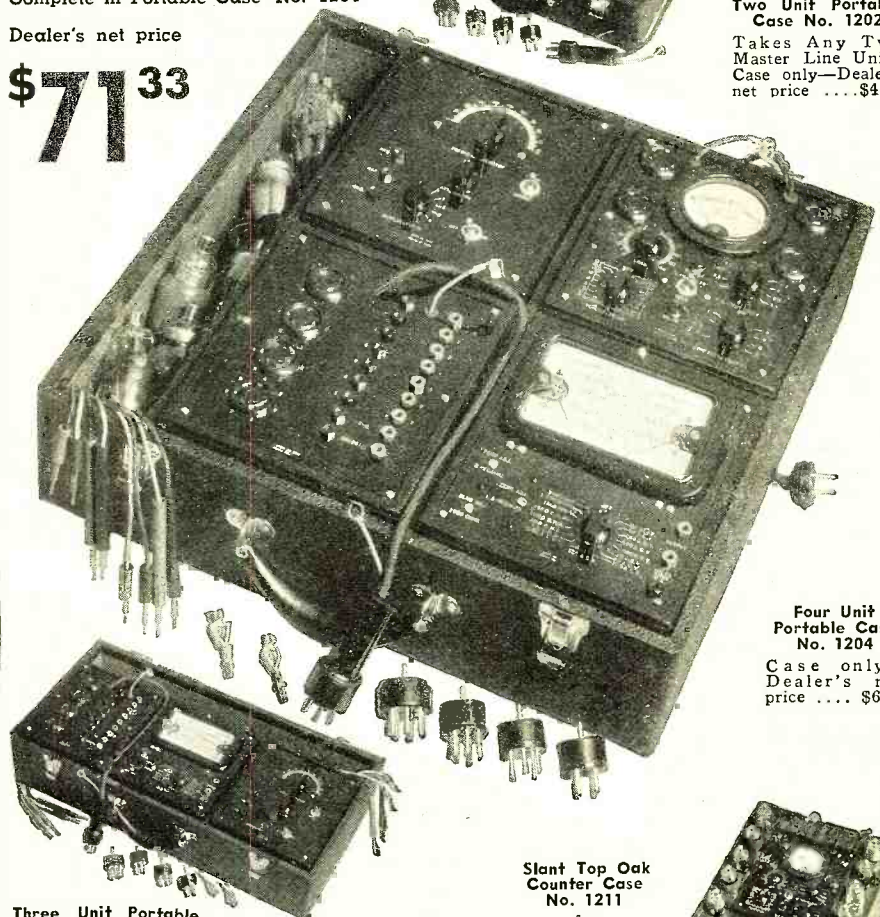

Two Unit Portable Case No. 1202  
Takes Any Two Master Line Units.  
Case only—Dealer's net price...\$4.67

Four Unit Portable Case No. 1204  
Case only—Dealer's net price....\$6.00

Three Unit Portable Case No. 1203  
Takes Any Three Master Line Units.  
Case only—Dealer's net price.....\$5.33

No. 1200 VOLT-OHM-MILLIAMMETER. Exclusive Triplett double AC and DC tilting instrument, readable from any angle. NO TESTER IS MODERN WITHOUT THIS FEATURE. Reads AC and DC up to 1000 volts. 250 DC milliamperes, 3 megohms. Gives output measurements. DC voltmeter has 2000 ohms per volt resistance. Dealer's net price.....\$21.67

No. 1210 TUBE TESTER. GOOD and BAD Scale. Line voltage control. Tests all inter-element shorts. Tests degree of leakages. Provides separate tests for diodes. Easily operated. Dealer's net price....\$20.00

No. 1220 FREE-POINT TESTER, used with No. 1200 to analyze radio sets. Tests voltages, currents, resistances, continuity, capacity from point-to-point. Complete with plug socket connections and lead wires. Dealer's net price.....\$8.33

No. 1230 ALL-WAVE SIGNAL GENERATOR. Supplies continuously variable signal, frequencies from 100 KC to 18 Megacycles, either modulated or unmodulated. Furnished with batteries and two Type '30 tubes, connecting wires and six graphs on large size charts. Dealer's net price.....\$15.33

Slant Top Oak Counter Case No. 1211 for TUBE TESTER No. 1210  
Case only—Dealer's net price.....\$4.00

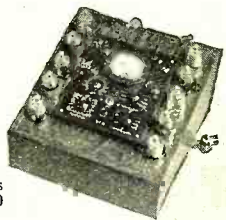

**Write for FREE Literature**

The Triplett Electrical Instrument Co.  
102 Main St., Bluffton, Ohio

Please send me details on the new Triplett Master Line Radio Testing Instruments.

Address.....  
Name.....  
City..... State.....

The Triplett Electrical Instrument Co.  
102 Main St. Bluffton, Ohio, U. S. A.



You can't go wrong  
with a RIDER  
Manual!



**VOLUME**



**IS READY**

**946 Models—1200 Pages  
112 Manufacturers**

Never before in the history of Radio has such a stupendous compilation of technical servicing material been collected between two covers. Expense was not spared to make Rider's Volume V all-embracing in its scope. Sets are explained even more lucidly than those of yesteryear, for complications galore are incorporated in 1935 receivers. Seeing is believing—step in your dealer's and prove to yourself that Rider's Volume V is without doubt the servicing sensation of the year... better than any other manual... the absolute peer!!

Volume I.....	1000 pages.....	\$7.50
Volume II.....	800 pages.....	6.50
Volume III.....	1070 pages.....	7.50
Volume IV.....	1040 pages.....	7.50
Volume V.....	1200 pages.....	7.50
Servicing Superheterodynes.....		1.00

Have your name put on the list to receive

**SUCCESSFUL SERVICING**  
our FREE monthly house-organ

**JOHN F. RIDER, Publisher**  
1440 Broadway, New York, N.Y.

Build Your Own

# SHALLCROSS UNIVERSAL TESTER

For \$41.50 Complete



- Volts A.C.-D.C.  
5-25-100-250-1000
- 1000 ohms per volt
- Milliamperes D.C.  
1-10-100-1000
- Capacity  
.001-10 Mfd.  
Paper or electrolytic condensers
- Inductance  
1-10,000 Henrys
- D. C. Resistance  
.5-5,000,000 ohms

Send 6c in stamps for the new Bulletin No. 611-D containing the complete wiring diagram and operating instructions for this modern serviceman's instrument.

**SHALLCROSS MFG. COMPANY**  
Electrical Measuring Instruments  
and Accurate Resistors  
700 MAC DADD BOULEVARD  
COLLINGDALE, PA.

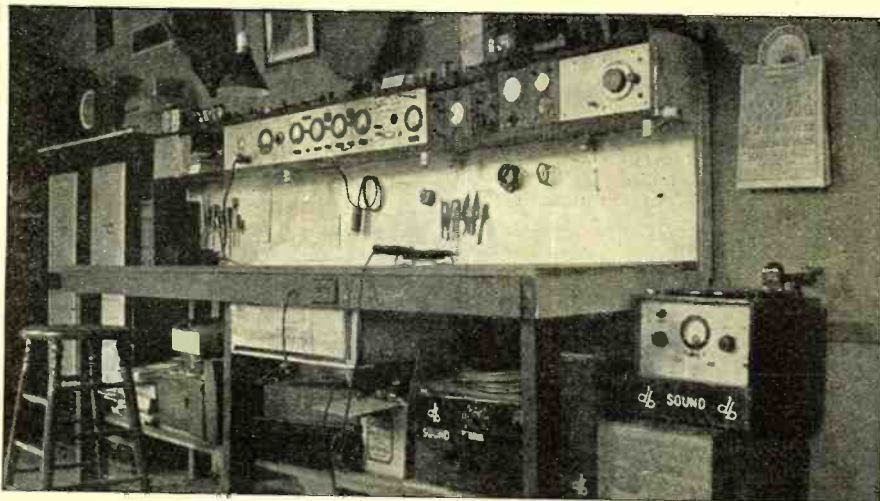

## THE SERVICE BENCH

ZEH BOUCK

### NEW YEAR RESOLUTIONS FOR THE SERVICEMAN

**W**HILE the first of the year may be no better a time than any other for the making of good resolutions, it is certainly no worse. Try these out—not on your piano—but on your cash register:

I resolve: To make the most of Service Sidelines, both those intimately connected with radio—accessories such as Remote Speakers, Phonograph Attachments, Recorders, Home-Speaking Mikes and External Oscillators for Short-wave Receivers—but also, P.A. Work, Motion-Picture Sound Equipment Servicing, House Wiring, Refrigerators, etc.

I resolve: To round out my Radio Service Business with more attention to Automobile Radio—Sales, Installation and Service.

I resolve: To learn a bit more about radio through Planned Reading and Study.

I resolve: To conduct my Service Work on a strictly Businesslike Basis, giving only a Fair and Profitable Allowance on Trade-ins, to charge reasonable prices for Time, Labor and High-grade Parts, neither to soak the customer when the soaking is good, nor to clip prices down to a "gyp" level, to control expenditures on the Budget System. Every job I do shall be well done! Every customer will be a satisfied client! I will follow up each job to make certain that such is the case!

I resolve: To Modernize my Equipment from time to time, and to Promote New Business through Publicity and Advertising—all in strict accord with the stipulations of my budget.

And just to start the year right, we present—

### THIS MONTH'S SERVICE SHOP

Don Blair, a frequent contributor to this department, is the proprietor of the neat and efficient service layout shown in this month's heading. Mr. Blair operates from Franklin, Pa. He finds the assembling and renting of sound equipment a highly profitable sideline. His own P.A. arrangement is shown in Figure 1, with the gentleman himself demonstrating his microphone stance in Figure 2.

The essential dope on the P.A. system is—a RADIO NEWS condenser mike, an 8-volt Willard battery, two -30 tubes, one -76 tube, two -41 tubes, and two 6-inch

automobile type speakers, loaded with plywood horns. The capacity is ample for a sound truck, and will take care of 1000 to 5000 people. We like the "DB" trademark!

### Condenser Testers

Appreciating the fact that many instances of intermittent reception may be traced to defective condensers, Mr. William E. Nye, Stewart-Warner Sales and Service, of Ottawa, Canada, sends us the following

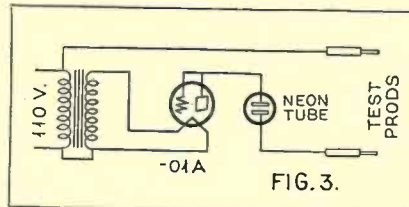

details on a condenser tester which he has found extremely valuable in tracking down trouble of this nature: "The circuit is shown in Figure 3 and is self-explanatory. The power transformer was made from a discarded audio-frequency transformer. The primary is wound with 440 turns of number 33 wire and the secondary with 30 turns of number 22. [This ratio gives a

FIGURE 2



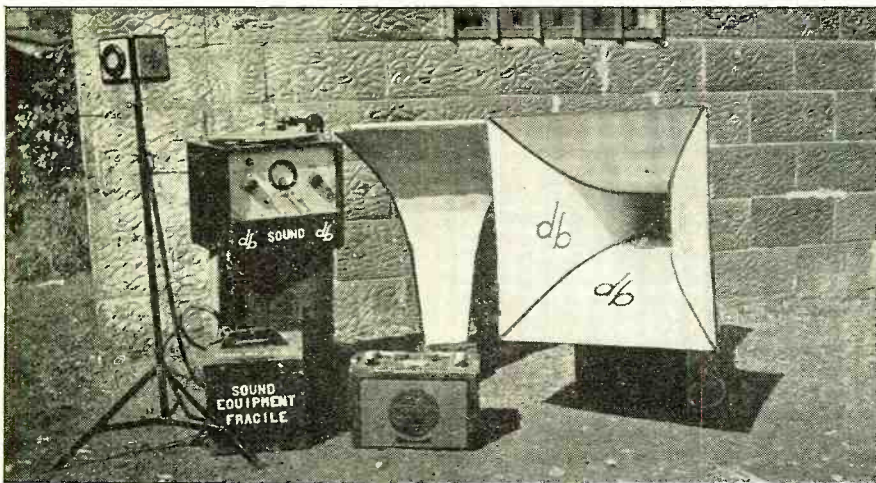

A NEAT PUBLIC-ADDRESS LAYOUT

Figure 1. This is Don Blair's portable P.A. equipment, placed on location and all ready to be installed. Notice the RADIO NEWS microphone. The "DB" trade mark is a happy one.

rather high filament voltage. We suggest 22 turns on the secondary.—*The Service Editor.*] The neon tube is a General Electric, 1-watt glow lamp, costing \$.56—the only expenditure necessary. In using the tester, be sure to disconnect the ground from the receiver to obviate the probability of a short in the power line. The neon tube will flash only once on a good condenser. A continued glow, or an intermittent one, indicates a defective condenser. We had a Stromberg-Carlson in the shop yesterday that developed a terrific hum after a few minutes' operation. This could be stopped only by turning the set off and letting the tubes cool. The condensers were checked with the latest type analyzer, and all tested okay. But with the neon tester, three filter condensers gave intermittent flashes. Replacing these condensers with perfect units cured the trouble."

Jack G. Follansbee, Toronto, Canada, also comes across with a condenser test: "Locating a short-circuited condenser in a circuit usually wastes a great deal of time if done by the eliminating method. If the serviceman possesses an ohmmeter with a low-range, such as 0-1000 ohms, the condenser may be found at once. Measure the resistance from ground to all the suspected condenser terminals (high side). The one which shows the least resistance will probably be the defective one. The resistance of the others in the same circuit will be several ohms higher due to the resistance of chokes, resistances, etc."

**Service Equipment**

In the efficient servicing of superheterodynes it is desirable to possess means of determining the effectiveness of the oscillator over the entire frequency range. C. Bradner Brown, of Kansas City, Mo., rec-

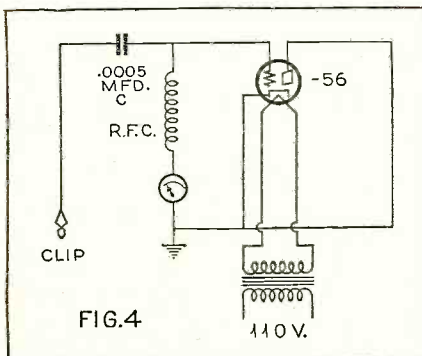

ommends for this purpose: "Perhaps the most difficult test to make on a superheterodyne is to determine whether or not the oscillator is functioning properly. The usual methods of indicating radio frequency cannot be applied, inasmuch as the oscillations are not very strong, and only in a few cases can a neon bulb indicator be used. The author set about designing a simple r.f. indicator that would work on even the worst type of oscillator, namely, the autodyne. The result is a simple arrangement using inexpensive parts, most of which will be available in the average service shop. The circuit is shown in Figure 4. No plate voltage is used, a small filament transformer being the only supply necessary. An 0-5 range, TM-108 tuning meter made by Readrite is employed as an indicator, although a more expensive milliammeter may be substituted. Where a calibrated scale is not desired, these tuning meters leave nothing to be desired as sensitive milliammeters. It will be noticed that the circuit is really a diode detector hook-up with a visual indicator. The clip, connected to the blocking condenser, C, is connected to the insulated plate of the oscillator condenser (usually the stator). This applies an r.f. voltage to the -56 which, in turn, is rectified in the grid-cathode circuit. This rectified current flows through the tuning meter and the resultant deflection indicates the strength of the applied r.f. wave. Thus a complete check on the strength of oscillations of the superheterodyne oscillator can be obtained in one operation. This indicator will not affect the circuit very much, and will prove a valuable asset in servicing supers, especially those having autodyne oscillators in which it is usually necessary to try several tubes before one is found which will work over the entire scale. The indicator can be connected and the tuning condenser run over the scale. If the oscillator quits working at any point, the tuning meter needle will fall back to zero."

**Auto-Radio Service and Replacement Manual**

Radio Dealers and Servicemen will find this new Mallory Elkon 28-page, auto-radio service and replacement manual extremely helpful in their work. In addition to general motor-car radio service data it contains a chart on the proper replacement Elkonode unit for all the popular auto-radio receivers and also for 32-volt models, as well as the approved Mallory Elkon B- (Continued on page 449)

*Shhh! Shhh!*  
**QUIET**  
*Please!*  
 Individually TESTED for NOISE  
**ELECTRAD**  
 QUIET  
**VOLUME CONTROL**

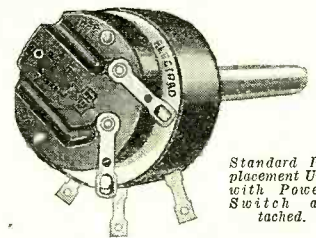

Standard Replacement Unit with Power-Switch attached.

**R**EVOLUTIONARY in its operating mechanism, Electrad's new *Guaranteed Quiet* Volume Control fills a long-felt want.

Absolute quiet, smooth, positive control of volume is accomplished for the first time in radio history.

**Built on a Radically New Engineering Principle**

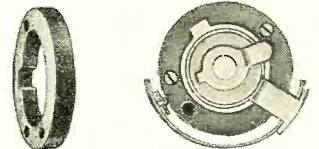

Resistance element based on flat outer rim of Bakelite ring.

Floating contact shoe glides over resistance element in straight path.

More even distribution of current, smoother control and longer life are attained with this construction. Molded Bakelite case, when mounted, projects only one-half inch behind panel. New type power-switch (approved by underwriters) instantly attachable. Long aluminum shaft—easily cut. All standard replacement values.

Mail coupon for descriptive folder.

from  
**RESISTOR**  
*Headquarters*  
 175 Varick St., New York, N. Y.  
**ELECTRAD**  
 1935 CATALOG  
 ELECTRAD, Inc.  
 175 Varick St., New York, N. Y.  
 Please send new 1935 Resistor Catalog. Check here for folder on new QUIET Volume Control.  
 Name.....  
 Address.....  
 MAIL COUPON FOR  
 RN-1

Train for  
**RADIO**  
IN 10 WEEKS AT COYNE

The great Coyne Shops in Chicago have a world-wide reputation for training men here in Chicago in this big-pay field in **only 10 weeks**. Then they get behind you to assure success by giving you, life-time employment service. By my new plan YOU can take advantage of their wonderful method of learning-by-doing NOW—no need to lose time and money while you strive and save to raise the necessary tuition.

**I WILL FINANCE YOUR TRAINING**

Come to Coyne at once. Get your training. Then start paying me for your training a full two months after your training period and take over a year to complete your payments. If you will write to me at once I will send you complete details of this sensational new plan, together with the BIG FREE illustrated BOOK telling all about COYNE and how many earn while learning, and training you can get there without book study or useless theory.



*H. C. Lewis*  
President

**SEND NOW FOR FULL DETAILS!**

**MR. H. C. LEWIS, President**  
500 S. Paulina St., Dept. 15-3K, Chicago, Ill.  
Tell me how you will finance my training at COYNE and send me the BIG FREE Illustrated Book on RADIO.

NAME.....  
ADDRESS.....  
CITY..... STATE.....

KENYON



PRODUCTS

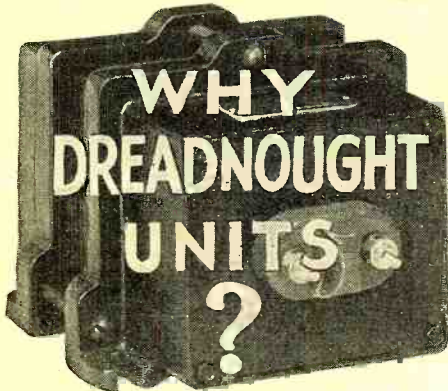

Because "ham" radio has gone commercial—in efficiency, reliability, reputation—these units offer features heretofore found only in built-to-order costly equipment for broadcasting, commercial and government services. Now in regular production. Offered at ham-pocket-book prices.

Featuring: New end castings. High insulation factor. Poured compound for efficient heat dissipation. Porcelain insulating bushings. Primary and secondary split windings brought to terminal boards as such, etc., etc. Complete line—plate supply, filament supply, Class B components, filter reactors, etc.

Ask your radio amateur supply house for literature. See the components for yourself. If not obtainable locally, write us for literature and name of nearest KENYON dealer also giving your own dealer's name.

**Kenyon Transformer Co., Inc.**  
840 Barry St.  
New York City



**THE TECHNICAL REVIEW**

JOSEPH CALCATERRA

*Electrical Measurements in Theory and Application*, by A. W. Smith; Third Edition McGraw-Hill Book Co., 1934. This text-book on electrical measurements might well be studied by those employed in the radio industry. It discusses many kinds of measurements with which the average radio man is not familiar, and also includes a brief review of electrical and magnetic theory. Furthermore, the author places an emphasis on electrical units, a subject which many never understand, and most others have forgotten. The text also covers the measurement of practically all electric and magnetic quantities.

*Electron Tubes in Industry*, by Keith Henney; McGraw-Hill Book Co., 1934. This is one of the books all of us have been wanting for a long time. Electron tubes are capable of controlling machinery and processes to a degree much more exacting than human beings could. There is indeed no end of possibilities and yet industry is accepting them rather slowly. Part of this delay is due to the natural shyness of anything new, especially if it looks so frail as an electron tube, and part of it is due to a lack of information. This book is intended to supply the latter. It is written for the engineer—not necessarily the radio engineer—and shows him the underlying principles of operation of each kind of electronic device and then shows how this can be used for measurement, counting, etc., etc. Heretofore, circuits for industrial applications have been scattered in various trade journals and scientific magazines; but now most of these have been collected within one book. The opening chapters give some brief review of electrical theory and then enumerate and define the various kinds of tubes such as vacuum tubes, gaseous tubes, mercury arc rectifiers, cathode-ray tubes, etc.

Then the author turns to vacuum tubes, explains the principles of their operation and follows it up by numerous circuits for vacuum tube voltmeters, various measuring and regulating instruments, etc. The same program is carried out for the gas-filled tubes, which include the "Tungar" bulb, etc. Then follow two chapters on the application of light-sensitubes. A study of the text does not require any previous knowledge of radio. However, some applications are not explained with sufficient clarity. Also, we had hoped that the author would include a table of tubes and their ratings since this information, especially on gaseous tubes, is so hard to obtain.

*Broadcast Receiver Design, All-Wave Receiver Design, High-Fidelity Receiver Design*, by G. S. Granger, Manson Publishing Co., 1934. These are three booklets of approximately 36 pages each, dealing with various problems in the design of

Broadcast receivers. They discuss such things as design of r.f. coupled circuits, oscillators, the problem of tracking, AVC, AVC, all-wave receivers, etc. The booklets should be of help to those who are already acquainted with radio and may desire to design receivers. The treatment is mostly non-mathematical.

**Review of Articles in the October, 1934, Issue of the Proceedings of the Institute of Radio Engineers**

*The WLW 500-Kilowatt Broadcast Transmitter*. The design, installation and performance of the highest power broadcast station at present in America is described in this paper. Unique features of the station include high-level Class B modulator producing audio-frequency outputs of 350 kilowatts, "isolation" operation of the control circuit, and concentric transmission line. Data is given comparing the performance of the vertical radiator used in this installation with that of a standard T antenna immediately adjacent.

*The Measurement of Harmonic Power Output of a Radio Transmitter*, by P. M. Honnell and E. B. Ferrell. A method of determining the harmonic output of a high-frequency radio transmitter.

*Regeneration Theory and Experiment*, by E. Peterson, J. G. Kreer and L. A. Ware. An experimental verification of Nyquist's criterion for the stability of linear feed-back circuits.

*Some Aspects of Parallel Resonant Circuits*, by L. M. Craft. The factors that determine whether the impedance of a parallel resonant circuit is a maximum or a minimum with respect to frequency. Analysis is made of such a circuit, determining the relation between inductance, capacity and resistance for a maximum or a minimum of impedance.

*North Atlantic Ship-Shore Radiotelephone Transmission During 1932-1933*, by Clifford N. Anderson. Contour diagrams showing the variation of signal field with time of day and distance for the winter, summer, spring and fall seasons and for the approximate frequencies 4, 8 and 13 megacycles. A comparison is made with the data obtained during 1930 and 1931.

**Review of Contemporary Literature**

*An Extension of Land Telephone Lines by Ultra-Short-Wave Radio*, by F. O. Merriam. Bell Laboratories Record, October, 1934. Design features and use of an ultra-short-wave connecting-link system



for the connection or extension of land lines across land or water areas.

*Magnetic Materials*, by I. C. Pettit. Bell Laboratories Record, October, 1934. This article describes the composition and properties of the various types of magnetic materials used in telephone apparatus.

*Acoustic Spectrometer*, by C. N. Hickman. Bell Laboratories Record, October, 1934. The theory and operation of the acoustic spectrometer, recently developed by the acoustical research department of the Bell Telephone Laboratories. The instrument is used to separate complex sounds into their simple component tones and at the same time indicates their approximate amplitudes.

*Power Factor Measurements in Oil Analysis*, by Robert F. Field. The General Radio Experimenter, September-October, 1934. A method of checking the condition of lubricating and insulating oils by means of comparatively simple power factor measurements.

*Dielectric Power Factor Measurements at Audio and Radio Frequencies*, by G. M. L. Sommerman. The Review of Scientific Instruments, October, 1934. A description of sensitive and accurate apparatus for measuring the power factor of dielectrics in the frequency range, 60-7,200,000 c.p.s. Some experimental power factor-frequency curves illustrating the results obtainable with this apparatus are given.

*Reverberation Measurements in Auditoriums*, by G. T. Stanton, F. C. Schmid and W. J. Brown, Jr. The Journal of the Acoustical Society of America, October, 1934. The problems encountered in attempts to measure the reverberation time in auditoriums are discussed in this paper.

*Notes on the Measurement of Radio Frequencies*, by W. H. F. Griffiths. The Wireless Engineer and Experimental Wireless, October, 1934. The various methods of making radio-frequency measurements, together with data regarding the accuracies obtainable and procedure which should be followed for best results are given in this article.

*Television: A Survey of Present-Day Systems*. Electronics, October, 1934. This article describes the various television systems which are available today and points out that television development has reached the stage where television reception of good entertainment value is practical, provided funds for transmissions can be obtained.

*All-Metal Vacuum Tubes*, by O. W. Pike and G. F. Metcalf. Electronics, October, 1934. This article describes the recent developments which have made metal envelopes, to replace the glass type, possible in modern vacuum tubes for industrial power purposes (not radio).

*Extending the Range of Ultra-High-Frequency Amateur Stations*, by Ross A. Hull. QST, October, 1934. This article describes some of the results obtained on 5 meters with the use of directive antennas.

*Sell Sets at "Point of Purchase."* Radio Retailing, October, 1934. There are a large number of retail stores, such as drug stores, grocers, markets, etc., which represent a vast market for the installation of radio sets and public-address systems as a means of entertaining customers while shopping.

*D.C. Shunt Installations*, by D. L. Van Leuven. Service, October, 1934. This ar-

(Continued on page 445)



**National Union plays Santa Claus to Service experts all year round!**

NATIONAL UNION gives tube testers, set analyzers, oscillators and service manuals with tube purchases. National Union gives these valuable instruments and servicing books so that service dealers can build a bigger better more efficient business for themselves. The instruments are all brand new models made by such famous makers as Supreme, Hickok, Triplett and Egert. The manuals are compiled by John F. Rider.

The alert Service-Dealer who equips himself the easy National Union way knows his equipment is backed both by the maker and National Union.

National Union gives service charts and data not available from any other single source.

National Union gives sales promotion aids and business forms.

National Union supplies radio tubes which are acclaimed by experimenters, amateurs and service experts for their accuracy and superiority. National Union tubes never fail to build customer good will. You can quickly prove this fact to yourself as thousands have already done.

Let National Union play Santa Claus to you Mr. Service-Dealer by giving you the instruments you need and giving your customers the fine radio performance they should demand!

National Union Radio Corp. of N. Y.  
400 Madison Ave., New York City

R.N.-1234



Tell me about.....

Name.....

Address.....

City.....State.....

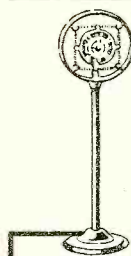

**Now You can Help them Hear**

Here is a new sales and profit-making unit for you from WEBSTER-CHICAGO . . . the Hard of Hearing PA system. Now you can go to churches, lodge-halls and other similar places and show them how those members of their congregation and memberships who are "hard of hearing" can participate in and enjoy the service and rituals as they haven't for a long time.

The WEBSTER-CHICAGO Hard of Hearing system is complete as shown here and will serve up to forty head-sets clearly and economically.

Write for detailed information and price.

Be sure your name is on the WEBSTER-CHICAGO mailing list.

New Bulletins are being prepared and will be available very soon on co-ordinated systems. You will want them.

**THE WEBSTER COMPANY**

3824 West Lake St., Chicago, Illinois

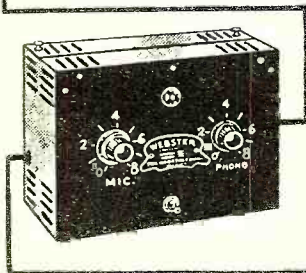

**RADIO ENGINEERING**

broadcasting, aviation and police radio, servicing, marine radio telegraphy and telephony, Morse telegraphy and railway accounting taught thoroughly. Engineering course of nine months' duration equivalent to three years of college radio work. School established 1874. All expenses low. Catalog free. Dodge's Institute, Oak St., Valparaiso, Indiana



**Now Ready The 1935 Profit Guide**

104 pages—Full of Marvelous buys. A complete line of public address amplifiers and equipment—short wave accessories — speakers — replacement parts—servicemen's supplies, etc.

Send for Your Free Copy Today  
Baltimore Radio Corporation  
721 R Broadway, New York, N. Y.

# AMERTRAN TRANSFORMERS

For Quality Amplification



## ANNOUNCEMENT

We have just completed a NEW 32-page Audio Bulletin. It is fully illustrated and shows our most complete line of highest quality standard transformers and reactors, including the standard DeLuxe type, the Miniature DeLuxe type, the Precision DeLuxe type and the SilCor types.

List prices are shown.

Write for your copy and prices  
When ordering ask for  
Bulletin 1002

**AMERICAN TRANSFORMER COMPANY**  
177 EMMET ST. NEWARK, N. J.



"E. H. Rietzke SPEAKING!"



Mr. E. H. Rietzke, President of CREI, and originator of the first thorough course in Practical Radio Engineering.

Is Radio . . .

## Just a Job to You?

If you can equip yourself with the necessary training . . . Radio can afford you a future that no other industry can offer. Continuous new developments have created a need for technically trained men, who have kept their knowledge up with Radio's fast pace.

**You Can't "Bluff"**

**Your Way in Radio . . .**

CREI courses are planned only for serious-minded men who know that it takes Training to qualify for, and to hold the big jobs and salaries that go with them. Let us suggest the course best suited for you and the easy ways of paying for it.

**Illustrated Catalogue Free**



Write today for your copy. Answers your every question and shows actual equipment used in our Residence School.

**CAPITOL RADIO ENGINEERING INST.**  
14th and Park Road—Washington, D. C.  
Dept. R. N. 1

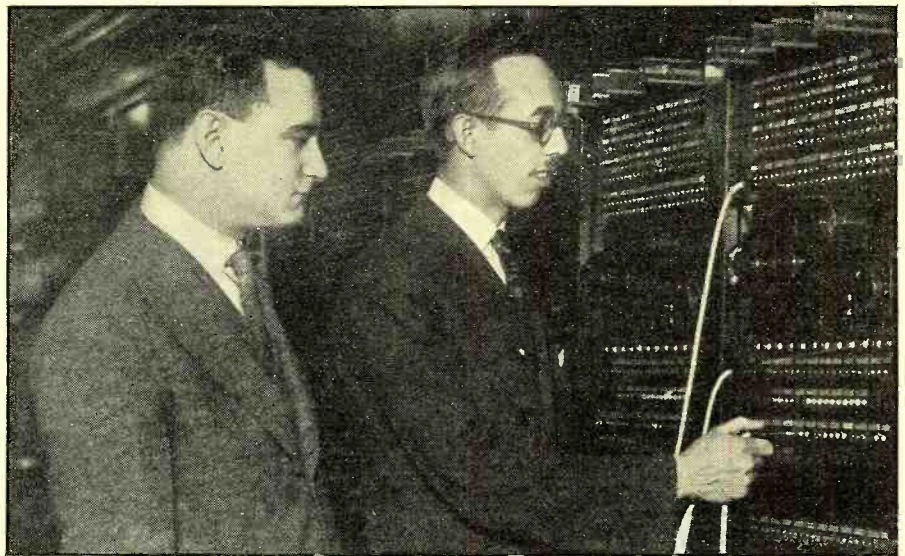

## QRD? QRD? QRD?

CONDUCTED BY G. Y.

OUR West-coaster reports that things out on that thar coast are "all to the mustard" as at this writing there isn't a first-class ticket without a good berth and that is something, as reports from other sections state that shipping is rather slow. Of course, that is no reason for the boys on this coast to grab the first plane for the land of sunshine and prunes. With Brother Matheson strutting his stuff out there, almost all stations and ships are 100% ARTA. There is great credit due him for his splendid showing in the short length of time he has been there. He added another feather to his cap when the IATSE Local (of Broadcast ops) broke up. He stepped right into the party and convinced the boys of the advantages of joining up with the ARTA. Furthermore, he has convinced shipowners and organizations of the importance of giving the operator a better wage and better working conditions.

It seems as though something ought to be done for the Airways ops who haven't been organized (as yet) out West. The various organizations for radiomen have paid little or no attention to this detail and the aviation radio men have been left high-and-dry with nobody giving them a break. Although aid has come to the brethren who sail the briny deep, the "sky-huggers" are still up-in-the-air. Now is the time for all good men to come to the aid of their party . . . and that isn't a typewriter lesson either, catch on? Several of the men report loss of jobs on airships due to "doubling up" duties. That is, acting as watchman or mechanic, etc. . . . It seems that Joe Meloan is now delegating, for the ARTA in the Los Angeles area, and it would be good business for him to drop around and speak to these air boys, what. Joe was formerly with KERN and is now president of the ITK.

From the stack of mail that has come to this desk asking for information as to the addresses of the various static rooms around the country, it appears that quite a few of the men are sticking 'round the old fireside, waiting until shipping picks up before they venture forth to the ports to try for billets aboard ship. Most of the letters came from the midwest and 90 percent came from men with second-class tickets who have as yet not been able to secure their first berth. It is a shame that these men, who have studied for a profession, cannot put into actual practice the

theories which have been pounded into their heads.

Well, it sure is going to be tough for the thieving profession, now that radio is on the job, to go places and do things. The Motorcycle Squad of the Police Department, not to be outdone by their brothers, "Sullivan and Mulligan," in the Radio Cars, have now been presented with a portable radio attached to their motorcycles. It was demonstrated successfully at the National Electric and Radio Exposition which was held in Madison Square Garden, recently. The only trouble with the darn things is that they are turned for a single frequency band and cannot bring in any music. Kind of tough on the cops, anyway.

With a new law likely to go into effect, the lowly "op" as well as the passenger will probably get a break. Congressman Celler of Brooklyn, N. Y., is going to ask President Roosevelt to take the first step toward changing the law of the sea which gives the Captain supreme choice of sending the signal of distress. If the skipper gives the order for the SOS and lives, he probably will be fired. So for this reason (plus his own personal ego) the average skipper waits until the water is up to the bridge deck before he notifies "Sparks" to tell the cock-eyed World he could use a bit of help. Which reminds me of the time I was aboard a seagoing tug and going through a No. 7 gale. We were heading for the open sea and due to the shack being in the place the icebox used to be (right below the wheel-house) every time the waves dashed through the open windows of the bridge, the water came seeping down into the shack covering the gaps on the 2½ kw. spark set. This set usually worked on half-a-lung (under good conditions) so one can imagine what happened when the salt water short-circuited the gaps. Well, we were all in the wheel-house and the ship was doing everything but staying on an even keel. Every moment we were expecting to take water into the funnel. Nobody got Mal de Mer (in any language it's the same—just plain seasick) because we were all busy mopping up the deck so the water wouldn't drop into the shack below. Well, after about the fourth time the ship did submarine duty, the Old Man looks at me and sez, "Y'think we oughter turn back, boy? I ain't never did such a thing in 25 years of going to sea,

fair weather or foul!" And I ups and sez to him, "Captain, you're liable to celebrate your 25th anniversary with Davey Jones if we do go out further." Thank the Lord the Old Man could stand a bit of reasoning or else this column would not have been written. The new law would also make some provision of restitution for salvage in the event the ship was saved by another vessel.

In a brief summary of the terrible S. S. MORRO CASTLE holocaust off the New Jersey coast, her Chief "Op," George W. Rogers, and Second "Op," George I. Alagna, lived a thrilling story of devotion to duty and cool-headedness in the face of fire and near-death. Rogers, at the key, and Alagna, fighting his way back and forth from the bridge to the shack, were true additions to the long roster of heroes of radio. Even after the storage batteries exploded and the hangings of the room had burned, Rogers kept sending the SOS although he could not receive. Much has been brought out in the testimony at the inquiry about these two men, but one thing cannot be taken from them and that is the way in which they handled a situation that was beyond the aid of human beings. Although Rogers did quote his dead Captain Wilmott's suspicions about Alagna (which later on was found to have developed because of Alagna's fight for better working conditions) he, Rogers, to show that he held no personal animosity toward Alagna, came to the offices of the ARTA, became a member and posed for pictures with him, giving out a statement emphasizing the fact that Alagna's record as an officer and as a fellow-worker was excellent.

Verbatim, we calls it, and here it is right hot off the griddle from the now-famous West-coaster . . . FLASH . . . Some Mexican stations need an operator-engineer and general manager who can persuade the American advertisers to try Mexico for their products. But the Mexican government only permits Americans in until they have had time to train Mexican help, or in most cases only six months, unless they possess a majority of shares in the corporation. Funny how many ops refuse to study for Executive jobs. How about some advanced courses on Business Management and Administration, or Law . . . Kenny Isbell of KECA and Joe Meloan are kept busy with the IRF (old I Tappa Key) for the better class of hams. No cash in it but lots of work . . . Merv Rathborne, he who started "CQ" and a new union (now the ARTA) left Frank Wiggins' school and got an assignment at KFS . . . Paul Whitmore of the "Y" radio school helps the ops out by showing them how to hit "BB's" with a BB pistol . . .

Lloyd Jones (of KFI) is now building a \$190 short-wave super-het which has more refinements than any set on the market today. Oh yes! . . . with facsimile and printer improvements some ops ought to be able to use this for a selling point to "hick cops" out in the sticks . . . Bob Kennedy sez to ask Joe Gately if he still remembers his trip to Norfolk regarding the Kennedy-Carter matter. Bob sez it's a darn good yarn . . . So look to your New Year Resolutions, and with a cheerio and toodleoo . . . 73 . . . ge . . . GY.

## A Discussion of Ohmmeter Design

(Continued from page 425)

the pointer followed the scale markings accurately; that is, if half-scale current was

indicated as exactly half-scale, the full-scale adjustment (battery-compensating adjustment) would correct most meter errors; except perhaps about 1/4 of one division error, due to error in the full and zero adjustment and error in reading (popularly known as parallax). The (current) scale distribution of such meters is not perfect, however; in other words, there is a small-scale distortion, so full correction at full-scale would probably reduce the errors at center scale by about 50 percent. Correcting the  $\pm 4$  percent error mentioned above by 50 percent would make it  $\pm 2$  percent (of half-scale) at half-scale. If we assume that an error of 1/4 of one division (of a 50-division scale) is due to zero and full-scale adjustment and error in reading, the balance of error at center-scale (1 percent) will be due to scale distortion (current, not ohmmeter, scale).

At 1/2 (current) scale an error in reading of 1/4 division of a 50-division scale (a little less than 1/2 of an inch, would be translated into a resistance error of  $\pm 2$  percent; and an error in (current) scale distribution (scale distortion) of  $\pm 1$  percent would mean a resistance error of  $\pm 2$  percent, or a total error of  $\pm 4$  percent in addition to the circuit error. At quarter (current) scale [approx. 3 times 1 (C) center scale, approx. .3 of 1 (D) center scale] an error in reading of 1/4 division would mean a resistance error of  $\pm 2.67$  percent; and a scale distortion of  $\pm 1.5$  percent (assumed as a compromise between 1 percent and 2 percent) would mean a resistance error of  $\pm 2$  percent, or a total error of  $\pm 4.67$  percent, plus the circuit error. At three-quarters (current) scale [approx. .3 of 1 (C) center scale, approx. 3 times 1 (D) center scale] an error in reading of 1/4 division would mean a resistance error of  $\pm 2.89$  percent, and a scale distortion of  $\pm .5$  of 1 percent (this value is assumed instead of  $\pm 1$  percent because this point of the scale is the nearest to the full-scale point, where the scale distortion error is corrected by the battery-compensating adjustment) would mean a resistance error of  $\pm 2.16$  percent, or a total error of  $\pm 5.5$  percent, plus the circuit error.

At 1/10 (current) scale [approx. 10 times 1 (C) center-scale or .1 of 1 (D) center scale] an error in reading of 1/4 division would mean a resistance error of  $\pm 5.5$  percent, and a scale distortion of  $\pm 3$  percent (assumed as a compromise between 1 percent and 5 percent) would mean a resistance error of  $\pm 3.33$  percent, or a total error of  $\pm 8.83$  percent, plus the circuit error. At nine-tenths (current) scale [approx. .1 of 1 (C) center-scale or 10 times 1 (D) center-scale] an error in reading of 1/4 division would mean a resistance error of  $\pm 4.95$  percent, and a scale distortion of  $\pm .25$  of 1 percent (assumed for reasons explained above) would mean a resistance error of  $\pm 2.75$  percent, or a total error of  $\pm 7.7$  percent, plus the circuit error.

At 1/50 (current) scale [approx. 50 times 1 (C) center-scale or .02 of 1 (D) center scale] an error in reading of 1/4 division would mean a resistance error of  $\pm 25.5$  percent, and a scale distortion of  $\pm 3$  percent (assumed for reasons explained above) would mean a resistance error of  $\pm 3.06$  percent, or a total error of  $\pm 28.56$  percent, plus the circuit error. At 49/50 (current) scale [approx. .02 of 1 (C) center-scale or 50 times 1 (D) center-scale] an error in reading of 1/4 division would mean a resistance error of  $\pm 25.75$  percent, and a scale distortion of  $\pm .05$  of 1 percent (assumed for reasons explained above) would mean a resistance error of  $\pm 2.52$  percent, or a total error of  $\pm 28.27$  percent in addition to the circuit error.

The next article will contain tabulated data on accurate home-made ohmmeters.

# LATEST TECHNICAL INFORMATION . . .

YOURS FOR 10c



Now available. A convenient 104-page Manual containing essential information users must have to get optimum performances from any device using vacuum tubes.

Complete data on over 90 receiving tubes. Base Symbols. Recommended Operating conditions, circuit applications, amplifier classifications. Over 150 cuts and diagrams. Represents months of painstaking research by Sylvania's famous technical staff.

This Manual is as necessary as your voltmeter. Just fill in the coupon, attach 10c in stamps and mail.

## YOURS! for 10c in STAMPS

### HYGRADE SYLVANIA CORPORATION

Makers of  
Sylvania Tubes  
Hygrade Lamps  
Electronic  
Products



Factories  
Emporium, Pa.  
St. Mary's, Pa.  
Salem, Mass.  
Clifton, N. J.

**Sylvania**  
THE SET-TESTED RADIO TUBE  
© H. S. CORP. 1934

Hygrade Sylvania Corporation  
Emporium, Pennsylvania (A-18)

Please send me the new Sylvania Technical Manual. I enclose 10c in stamps.

Name.....

Address.....

City..... State.....

**Before You BUY Try**  
**BUD**  
 P. A. Equipment  
**5 DAYS**  
**ABSOLUTELY FREE**

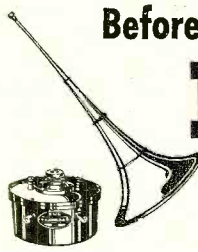

BUD engineers challenge you to duplicate Bud's sensational performance and proved dependability at any price! BUD'S FREE FIVE-DAY TRIAL enables you to accept that challenge, with no obligation to you! Write today for beautifully illustrated descriptive folder, prices, and full details of FREE FIVE-DAY TRIAL offer.

- PORTABLE SOUND SYSTEMS**
- ELECTRO DYNAMIC UNITS
  - CARBON MICROPHONES
  - AMPLIFIERS
  - 4, 5 & 6 FT. ALL ALUMINUM TRUMPETS
  - FIELD EXCITERS
  - AIR COLUMN HORNS
  - LOW AND HIGH FREQUENCY UNITS FOR WIDE RANGE THEATRE USE

**BUD SPEAKER COMPANY**  
 1132 JACKSON STREET • TOLEDO, OHIO, U.S.A.



**"MODERN RADIO SERVICING"**

**An Announcement:** To all those who have been soliciting us for information about Ghirardi and Freed's monumental new treatise on servicing, we take this opportunity to announce that publication will be delayed a few weeks in order to allow the authors time to incorporate important advance data and information that has just come into their hands and which will be of the utmost value and interest to all servicemen.

Announcement of publication, together with a full description of the book, will be sent to all who send in their requests to us. Orders will be filled strictly in the order received.

**DENTON'S S. W. HANDBOOK**

In one small handbook Clifford E. Denton has condensed all the real dope on short-wave practice as it is today—diagrams, data, tables, photos, set construction—everything you need to know. \$1 postpaid while the present edition lasts.

**GHIRARDI'S RADIO Physics COURSE**

Radio theory and all its practical applications in this one standard text and reference book. The first book to get—the last to part with! 972 pp., 508 illus. \$4 postpaid.

Send postcard for free literature  
**RADIO & TECHNICAL PUB. CO.**  
 45 Astor Place, New York, N. Y., Dept. RN-1



**RADIO PHYSICS COURSE**

ALFRED A. GHIRARDI

**Lesson 36**

**Capacitor Properties**

**T**HE breakdown voltage of solid dielectric materials becomes lower as the temperature is raised. For this reason, condensers should be mounted so that they are not too close to hot objects such as vacuum tubes, power transformers, etc., and plenty of ventilation should be provided around them. Breakdown is a function of time as well as voltage. A condenser that stands up satisfactorily under several thousand volts for a few seconds, might break down when connected to a 2000-volt line for several hours. For this reason, a "flash-voltage" test given to condensers for a few seconds at the voltage they are to work at in practice is not a reliable indication of the voltage they will be able to stand under steady service. Obviously it is not practical in quantity production of condensers to apply the correct test voltage for hours. Therefore the R. M. A. specifies the voltage test for fixed paper condensers as: "A single application of *two times the rated working voltage for 15 seconds*, and the immediate discharge through a resistor of sufficient ohmic resistance (50 ohms or more) to limit the discharge current to not more than one ampere. The use of the resistor in discharging the condenser is to prevent damage to the condenser by the too rapid discharge which would occur if its terminals were merely "shorted" by a wire.

The *working voltage*, that is, the maximum voltage which may be applied steadily to the condenser with out harm, is usually marked on the case. Condensers connected in non-pulsating direct current circuits are subjected to a voltage equal to

tube in the output circuit of B eliminators. For instance, in a filter circuit in which a sine-wave voltage having an effective value of 500 volts exists, the peak voltage applied to a condenser in the circuit is  $500 \times 1.41 = 705$  volts, as shown at (C) of Figure 1. Therefore, a condenser having a rated maximum working voltage of at least 750 volts or over should be used in this circuit instead of a 500-volt condenser. At (A) is shown the condition where 500 volts steady d.c. is connected to the condenser. At (B) a pulsating d.c. having an effective voltage of 500 volts is applied. The peak voltage is somewhat higher than 500 volts.

In some circuits in which a pulsating direct voltage is applied, the extent of the pulsations may not be known. In such cases it is always best to be on the safe side, and figure that the pulsations are such that the peak value will bear the same relation to the effective value that an alternating current would, that is, 1.41.

As the manufacturers of condensers have no way of knowing whether their condensers will eventually be used in smooth d.c., pulsating d.c. or a.c. circuits, many of them mark both the d.c. and a.c. rated working voltages on them to eliminate the necessity for calculation on the part of the purchaser. Thus, a representative commercial filter condenser examined may have the following marking on its label: Cap 2 mfd., working voltage 400 volts, d.c., 250 volts a.c. It must be remembered that the maximum or "peak" value is 1.41 times the effective value only in the case of a sine-wave voltage. If the sine-wave variation of voltage does not exist, this relation will be greater than 1.41 if the wave is greatly peaked and less than 1.41 if the wave is more flattened. In filter circuits of B eliminators, the voltage wave existing immediately following the rectifier

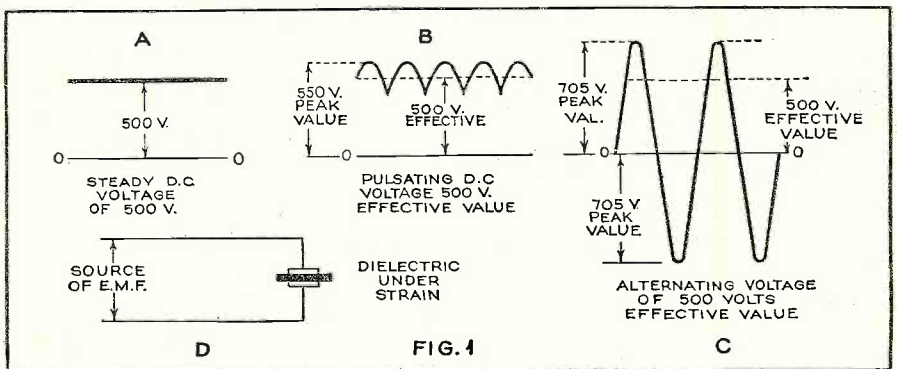

Figure 1. The dielectric in a condenser must be able to safely withstand the "peak" voltage in the circuit

the normal d.c. voltage of the circuit. In alternating current circuits, the voltage rises from zero to its peak value twice during each cycle, or 120 times a second for a 60-cycle current. The maximum or "peak" value of a sine-wave alternating voltage is 1.41 times the effective value. The effective value is that value which an a.c. voltmeter reads when connected in the circuit. Since the dielectric is subjected to, and must be able to stand without breakdown, this peak value twice during every cycle, it is the peak value of the voltage which must be considered when selecting a condenser which is to work in an alternating current circuit, or in a pulsating direct current circuit where the current is varying in value, as in the case of the filter condensers in the positions immediately following the rectifier

tube is usually not of true sine-wave form, so that the allowable a.c. working voltages of filter condensers for use in these circuits are usually less than would be obtained by the use of the factor 1.41. For instance, in the 2 mfd. condenser considered above, 400 divided by 1.41 would give 283 volts for the a.c. working voltage on the basis of a sine-wave voltage. As the voltage wave-form existing in the usual B eliminator is more peaked than this, the a.c. working voltage of only 250 volts is allowed in the particular filter condenser mentioned. If the voltage is not of the sine-wave form, the peak voltage may be measured either by means of an oscilloscope or a special "peak voltmeter."

The breakdown voltage of a condenser depends mostly upon the material used for

the dielectric and the thickness of the dielectric, or separation between the plates. Since most solid insulating materials require more voltage to break them down than air does, a condenser built to stand a certain voltage can be built with the solid dielectric thinner and therefore more compact than if air were used for the dielectric. For instance, in a certain paper-dielectric type condenser having a maximum d.c. working voltage rating of 1000 volts, the paper dielectric is .003 inches. In an air-dielectric variable condenser rated at 1000 volts, the air dielectric or separation between the plates is .025 inch, over 8 times as much.

The thicker the dielectric is made, the greater is the breakdown voltage. Factors which affect the breakdown voltage of dielectrics will be discussed later when studying these dielectrics. As we shall see later, the greater the separation between the plates, the less is the capacitance of the condenser. Thus these two factors conflict, for while manufacturers would like to make the dielectric as thin as possible in order to make the condenser more compact and cheap, the dielectric must be made thick enough to stand the voltage which the condenser will be called upon to withstand in service.

### Capt. Hall's Page

(Continued from page 414)

York City, in answer to a reception report sent KAY, Manila, on July 17. We were patiently awaiting a veri from there, but in its place arrived this communication from New York. Here is what they said, in part: "This will acknowledge receipt of your letter dated July 18, in which you report the interception at 15:33, G.M.T., July 17, of radiotelephone transmission from KAY." Then they go on to say that the power of their station varies from one to forty kilowatts, according to transmission conditions. Usually a directional antenna is employed. These communications are considered "point-to-point" and therefore "we may not supply any confirmation of material transmitted by our station." After waiting four months we receive this reply to our letter, which had gone all the way to Manila and then back to New York, to be answered. In other words, *Manila does not verify!*

From Java we received information on their short-wave broadcasting stations, also their commercial phone circuits. Short-wave clubs in the Far East possession of Holland have sixteen assigned wavelengths, the lowest being 86.46 meters and the highest 163 meters. Short-Wave Concession Broadcast Company, NIKROM, has from 49.02 meters (YDA) to 196.1 meters. These stations broadcast from 3:30 to 6:30 a.m., 10:30 a.m. to 4 p.m., 10:45 p.m. to 11:45 p.m., Eastern Standard Time.

The Javanese phone stations, which broadcast occasionally, using directional aeriels towards Europe, America, Australia ant the Far East, are: PMA, 15.51 meters, 40 kw.; PLE, 15.93 meters, 40 kw.; PMC, 16.55 meters, 40 kw.; PLP, 27.27 meters, 2 kw.; PMN, 29.24 meters, 3 kw.; PLV, 31.90 meters, 80 kw. All these stations are in Bandoeng. In Medan they have YBG (28.76 meters) and in Makesser, PNI (34.19 meters). Both stations have only 3 kw. power. A sharp-eared tuner is liable to run afoul of one of them most any morning. Java verifies all correct reports.

*Capt. Horace L. Hall*

### Skip Band Set

(Continued from page 416)

section comprising a regular plate, grid and the common cathode also used for the diode sections. The amplified a.f. signal works into a resistance-capacity coupled audio power stage employing the type -42 tube, V5

The grid-return leads of i.f. transformers IF1 and IF2 do not return to ground directly, but run through resistor R2 and the entire resistance of potentiometer R1. This connection places the cathode end of R1 at positive potential and the opposite end at negative potential. Negative bias for the control grids of the i.f. tubes V2 and V3 is thus obtained because of the voltage drop through R2 which occurs during the detecting-rectifying action.

For a given signal, let us assume that the drop across R1 is enough to bias the controlled tubes V2 and V3 to a sensitivity consistent with desirable reception volume. A decrease in signal input causes a decrease in voltage drop across R1. This automatically lowers the bias on V2 and V3, and the sensitivity of the i.f. amplifier increases accordingly. Conversely, a stronger input signal increases the voltage across R1, biases the i.f. tubes more negatively, and the receiver sensitivity decreases to hold the receiver output level constant. This entire action constitutes a system of effective automatic volume control.

Without some sort of manual audio control, the receiver would always be working at peak output. Any desired volume level is maintained by adjustment of the knob of R1, which allows all or any part of the rectified signal current to pass to the audio section of V4 for amplification and eventual reproduction.

The field winding of the 5½-inch dynamic type speaker serves as the filter choke for the power supply. The power pack is of standard design.

The small size of this receiver makes it ideal for installation in a book-case and in a wide variety of mantel or small console cabinets. The sensitivity, selectivity and tone quality of the receiver are more than adequate for all ordinary requirements, the crisp, lifelike reproduction of voice and music being especially impressive when the speaker is fitted to a baffle of respectable size. *The above statements by the author on the operating ability of the set have been borne out by tests conducted in the RADIO NEWS Laboratory.* A kit of parts for building this receiver has been made available by Wholesale Radio Service, Inc.

### What 1935 Holds for Television and Facsimile Transmission

(Continued from page 402)

three hundred or more lines may be picked up out of doors or in the studio, with about the same light intensity as is required for talking movies. Recent development of a new type of cold-cathode vacuum tube called the "electron multiplier" has led to greatly increased sensitivity of the television pick-up camera and has opened the way to more efficient radio transmission and reception of television signals. Television is still in the laboratory in the United States, but it is not going to remain there much longer.

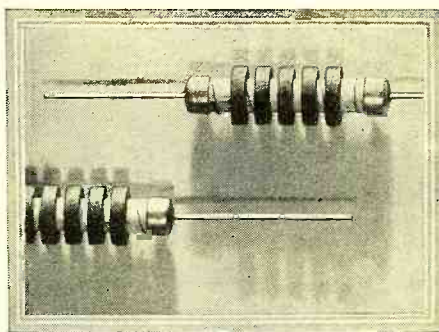

MIDGET R. F. CHOKE

## HAMMARLUND CHOKES

*Unequaled in Quality Features, and so Inexpensive They Can be Used Generously!*

THERE are many places in a circuit where radio-frequency filtering is needed for best results—such as detector plate circuits, all B+ leads and all grid leads.

And now that Hammarlund's new "CH-X" MIDGET R.F. CHOKE is perfected and costs so little, you can afford to use it wherever desirable.

The "CH-X" is the smallest and lightest R.F. Choke ever devised. Its features are exclusive. It is in a class by itself.

Only ½ in. x 1½ in. in size, it is small enough to fit where space is at a premium, and so light in weight that the tinned copper leads afford ample support. The leads, extending straight from the end caps, greatly facilitate convenience and neat wiring. The end caps are small, thin and scientifically spaced so that distributed capacity to the adjacent coils is at a minimum.

Inductance is 2.1 mh. Five universal-wound, impregnated pies on Isolantite core. Price only 75c each, less 40% to experimenters.

Mail Coupon for Details

Hammarlund Manufacturing Co.  
424-438 W. 33rd St., New York

Check here and attach 10c for 16-page Hammarlund 1935 Short Wave Manual illustrating and describing most popular S-W circuits of past year, with schematic and picture diagrams and parts lists.

Check here for FREE information on Hammarlund Chokes.

Check here for FREE General Catalog.

Name.....

Address.....

.....RN-1



# Train Now for New RADIO Opportunities

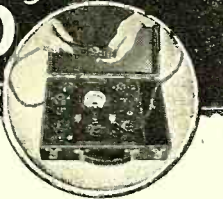

Get Into a Line Where There's Action—Every Day—And a Payday Every Week—You Be the Boss!

**Analyzer & Resistance Tester—Latest Design—Yours Without Extra Cost**

Right now while hundreds are looking for work where there isn't any, the radio service field can use trained men. With the proper training and the necessary equipment, you can enter this field and make a comfortable living. We include with our course this modern set analyzer and trouble shooter without any extra charge. This piece of equipment has proved to be a valuable help to our members. After a brief period of training, you can take the set analyzer out on service calls and really compete with "old timers." We show you how to wire rooms for radio—install auto sets—build and install short-wave receivers—analyze and repair all types of radio sets—and many other profitable jobs can be yours. Teaching you this interesting work is our business and we have provided ourselves with every facility to help you learn quickly yet thoroughly. If you possess average intelligence and the desire to make real progress on your own merits, you will be interested.

## ACT NOW—MAIL COUPON

Start this very minute! Send for full details of our plan and free booklet that explains how easily you can now cash in on radio quickly. Don't put it off! Write today! **Send Now!**

**RADIO TRAINING ASSN. of AMERICA**  
 Dept. RN 51, 4513 Ravenswood Ave., Chicago, Ill.  
 Gentlemen: Send me details of your Enrollment Plan and information on how to learn to make real money in radio quick.

Name.....  
 Address.....  
 City..... State.....

## JUST OFF THE PRESS!



**FREE Radio and Amplifier CATALOG**

**100 PAGES OF BIG MONEY SAVING VALUES**

Entirely New from Cover to Cover!

Filled with Latest Design Portable, Mobile and Rack and Panel, Public Address Amplifiers, Short-Wave and All-Wave Receivers and Converters, Inter-Office Call Systems, Test Equipment, Replacement Parts, Kits, Tubes, and Accessories—all at unbeatable Rock Bottom Prices!

**WE ARE HEADQUARTERS FOR PUBLIC ADDRESS SYSTEMS**  
 "COAST-TO-COAST" Presents a New Line of **1935 P.A. AMPLIFIERS**

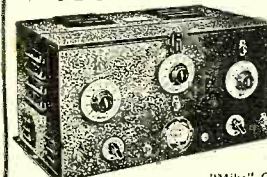

These improved modern Amplifiers employ an all-steel black crystalline finished housing with hinged top and ventilating louvers. Available with optional self-contained "Input Mixer-Fader" Control Panel, Combination Output Meter and "Mike" Self-Contained Meter, Current Supply, etc., etc.

Models available for operation from either a 6 Volt Storage Battery, or 110 Volt A. C. Universal Models may be operated from both 6 Volts D. C. and 110 Volts A. C. Portable Models, too. Entire line, ranging in audio output from 5 Watts to 100 Watts, completely described in our FREE catalog shown above.

**Buy Direct from the Manufacturer and Pay Only One Profit!**

**COAST TO COAST RADIO CORP.**  
 123-N WEST 17th ST. NEW YORK, N. Y.

# WHAT'S NEW IN RADIO

WILLIAM C. DORF

## New Dual-Wave Receiver

The Freed-Eisemann model 469 a.c.-d.c. six-tube table type receiver covers the short-wave bands from 15 to 51 meters in addition to the regular broadcast band from 200 to 560 meters. The two wave-length ranges are indicated on the tuning scale. The broadcast band is calibrated in kilocycles and the short-wave bands in

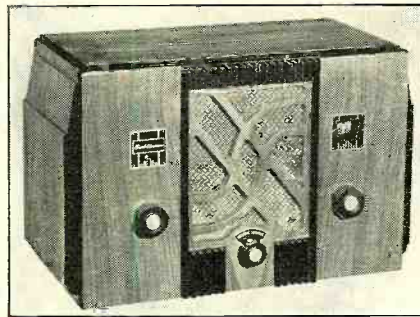

meters. The location of the various short-wave ranges is indicated by red colored markings on the scale. The set employs one 6A7, one 76, one 78, one 77, one 43, and one 25Z5 rectifier tube. It measures 8 1/4 inches high by 12 1/2 inches wide and weighs approximately 10 pounds.

## New Products

The new National mica dielectric midget padding condenser shown in the first illus-

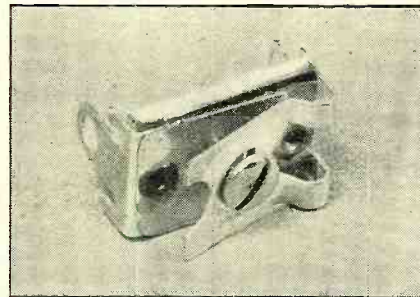

tration is mounted on Steatite insulation. This new product is so light in weight and extremely small that it can be conveniently

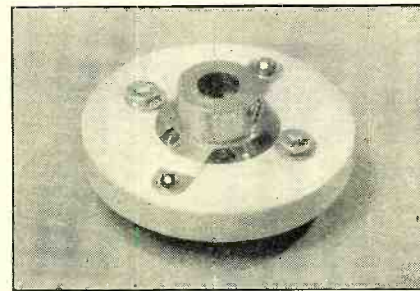

mounted directly on the connecting leads. The second illustration shows the National TX-10 transmitting type flexible coupling. This unit is also Steatite insulated and is made for 1/4 inch shafts.

## New High Fidelity Speaker

The accompanying illustration shows the new Jensen model Q, high-range speaker designed to reproduce all useful frequencies above 1200 c.p.s. Power handling capacity, peak input of 5 watts to the voice coil. The impedance of the voice coil is 16 ohms at 3000 c.p.s. The dimensions of the

speaker are: 9 5/8 inches from front to back, 8 1/8 inches high and diameter of the bell 5 1/4 inches. The use of this type speaker is, of course, restricted to association with

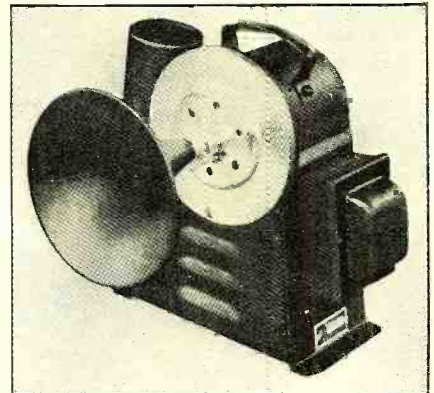

other speakers reproducing the low frequencies, together with suitable equipment for providing a low and high frequency channel from the amplifier.

## Test Oscillator

The frequency range of the new Miller model No. 350 test oscillator is completely variable over a range from 125 to 1500

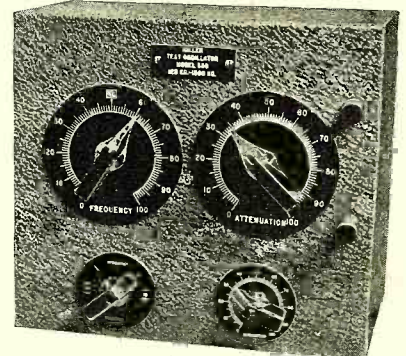

kilocycles. The instrument employs the fundamental frequency—not the harmonic. Each oscillator is individually calibrated on at least 32 points from a master oscillator which is held constant within .015 of one percent. It is equipped with a smooth operating attenuation control and a variable modulation control. The frequency range dial covers 300 degrees rather than the usual 180 degrees. A complete kit of parts is available for those who wish to build the instrument.

## A Powerful Class A Prime Amplifier Kit

The United Transformer Corporation announces a ten-tube power amplifier kit with a gain of 90 db. and a maximum undistorted output of 38 watts. The amplifier is designed to drive 10 power dynamic

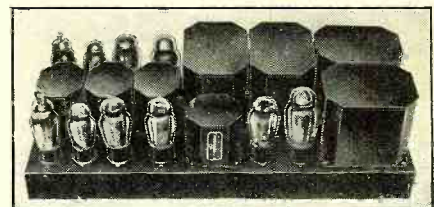

type speakers to full output or up to 20 dynamic reproducers at a normal power

level. The input connections are for a detector plate output and a double button microphone. The output connections are 500, 200, 16, 8, 5, 3 and 1½ ohms. Three balanced push-pull stages employ the following type tubes: two 57's, which are triode connected, two 56's and four 45's in a Class A-prime parallel push-pull circuit. The type 83 rectifier is used for the plate supply and a type 45 tube is utilized as a separate C bias rectifier for the output stage. The amplifier measures 22¼ inches by 8¼ inches. A schematic diagram and constructional information are enclosed with each amplifier kit.

### Calibrated Replacement Dials for Small Meters

The illustration herewith shows three new metal Van Leuven replacement dials for small meters that should be of more than passing interest for servicemen and

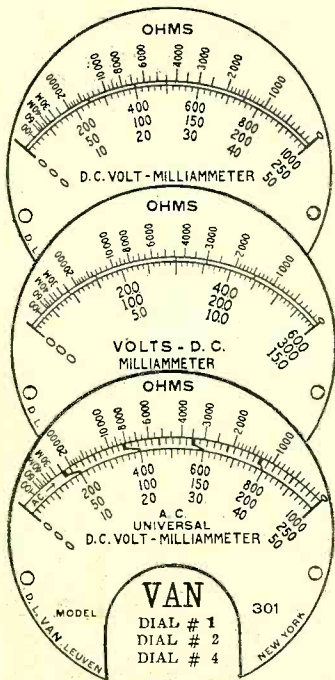

experimenters who are accustomed to build and modernize their own test equipment. These dials can be attached readily to existing low-current milliammeters and the meters thus made into multi-reading meters for current, voltage and resistance by simple use of shunts, resistors, etc. Many other ranges may be obtained by changing the decimal point.

### The Technical Review

(Continued from page 439)

article gives non-technical information on the application and use of shunts in connection with small meters having standard characteristics.

### Technical Booklets Available

2. *1935 R.F. Parts Catalog.* Specifications on the line of Hammarlund variable and adjustable condensers, r.f. transformers, sockets, shields, and miscellaneous parts for broadcast and short-wave receivers.

4. *A 15- to 200-Meter Superheterodyne.* Outstanding features of the Hammarlund-Roberts high-frequency superheterodyne designed especially for commercial operators for laboratory, newspaper, police, airport and steamship use.

5. *A 1935 Volume Control and Resistor Catalog.* Data on standard and replace-

ment volume controls, Truvolt adjustable resistors, vitreous wire-wound fixed resistors, voltage dividers, precision wire-wound non-inductive resistors, high-quality attenuators, center-tapped filament resistors, power (50-watt) rheostats and other Electrad resistor specialties.

6. *Line Voltage Control.* Characteristics and uses of a voltage regulator and chart showing the correct Amperite recommended by set manufacturers for their receivers.

7. *Rich Rewards in Radio.* Interesting information on the growth of radio and the opportunities existing in the field of radio manufacturing, radio servicing, broadcasting, talking pictures, television, public-address systems and commercial station operation on land and sea, for men who are trained to fill the many jobs created by the radio and allied industries. The book also contains detailed information on the complete home-study courses in radio and allied subjects offered by the National Radio Institute.

25. *Noise-Reducing Antenna Systems.* Two types of noise-reducing systems perfected by the Lynch Mfg. Co. for both broadcast and short-wave reception.

26. *Auto Radio Antennas, Filters and Noise Suppressors.* The line of Lynch antennas, filters and ignition noise suppressors especially designed for motor radio installations. Data on how to eliminate motor radio noise is included.

27. *The Autostat Charging Rate Booster.* This folder describes the new Lynch Autostat designed to automatically increase the charging rate of the automobile car generator by five amperes every time the car radio is turned on, so as to eliminate danger of running down the car battery while the radio set is in operation.

34. *Serviceman's 1935 Replacement Volume-Control Guide.* Revised list, in alphabetical order, of all old and new receivers showing model number, value of control

## MAKE MORE CALLS and BIGGER PROFITS

with New **READRITE** Point to Point **TESTER** • No. 720 •

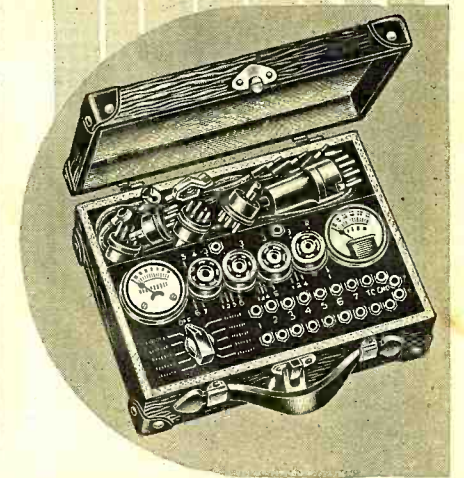

Here is the tester that every serviceman needs for properly servicing radio receivers. The new Readrite No. 720 Tester enables you to make more calls per day at less cost per call—and make bigger profits because of its speed, its accuracy and its dependability.

The new No. 720 unit operates *faster . . . more efficiently* and with *less manipulation*. It tests all resistances, continuities, voltages, current and capacities from the set socket by the reliable point-to-point method. And it is built to withstand severe field service.

Two highly developed Vane-type AC and DC meters are incorporated into this new tester. They are simple in design and dependably accurate. The DC scales are 15, 150, 300 and 600 volts, 15-150 milliamperes. AC scales 10, 25, 150 and 750 volts.

### Your Jobber Can Supply You . . .

with the Readrite No. 720 Tester at Dealer's net price of only \$15.00. Write direct for literature to

**READRITE METER WORKS**  
135 College Avenue Bluffton, Ohio



### MAIL COUPON FOR CATALOG!

Readrite Meter Works,  
135 College Ave., Bluffton, Ohio

Send me catalog on Readrite No. 720 Tester and folder proving Readrite leadership.

Name.....

Address.....

City..... State.....

January, 1935  
RADIO NEWS Free Technical Booklet Service  
222 West 39th Street  
New York, N. Y.

Gentlemen: Please send me, without charge, the booklets or folders I have filled in below:

Numbers.....

.....

My occupation or connection in radio is checked off below.

Serviceman Operating Own Business  
Serviceman Employed By:  
 Manufacturer  
 Jobber  
 Dealer  
 Servicing Organization

Dealer  
 Jobber  
 Radio Engineer  
 Experimenter  
 Laboratory Technician  
 Professional or Amateur Set Builder  
 Licensed Amateur  
 Station Operator  
 Public Address Work

I am a  subscriber  newsstand reader.

I buy approximately \$..... of radio material a month. (Please answer this question without exaggeration or not at all.)

Name.....

Address.....

City..... State.....

PLEASE USE PENCIL AND PRINT, IN FILLING IN COUPON

## INTERNATIONAL RECEPTION!

### 8-Tube Universal Wave Super-HETRO-Dyne

SHORT • BROADCAST • LONG WAVES

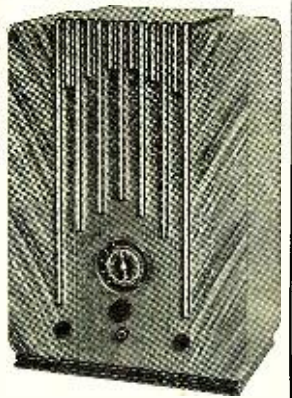

Tuning  
15 to 100,  
200 to  
555,  
732 to  
2200,  
Meters.

Flying  
Weather  
Reports,  
Beacon  
Signals,  
Every-  
thing on  
the Air!

Multi-Coil  
Uni-Tuned  
Assembly  
on all  
Wave  
Bands

Complete in DELUXE CABINET  
with Dynamic Speaker & Tubes  
**RETAIL PRICE \$70.50**  
**WRITE FOR DISCOUNTS**

New superheterodyne circuit with a unique Antenna. R.F. pre-selector and Oscillator coil assembly. Perfect resonance and maximum selectivity and sensitivity in all wave-lengths. 4-position switch changes wave bands.

3-gang condenser. Oversize transformers. Licensed dynamic speaker. Airplane dial calibrated in all wave-lengths. Tone control. Automatic Volume Control. Phonograph jack. Processed for tropical operation. Also available chassis, speaker and tubes only, phono-combinations and console cabinets.

We allow very large discounts. The extensive HETRO line offers real money-making opportunities. Write for our discount today.

**HETRO ELECTRICAL INDUSTRIES, Inc.**

4220 Lincoln Ave. Chicago, Ill., U. S. A.  
Cable Address "HETRO" All Codes

### "23 Lessons in Radio" FREE!

with 5 issues of Radio News at \$1  
(Canada & Foreign \$1.50)  
RADIO NEWS, 351A, 461 Eighth Ave., N. Y. C.

# Antenna!

back into the  
radio picture  
with both feet

PUT IT UP to your service man, is the theme song of our latest catalogue, on the back of which appears a map showing location of important foreign and American short-wave stations.

The other side of the sheet explains the importance of the correct antenna in the modern scheme of reception.

Lists several typical CORWICO kits and also antenna parts. Urges the reader to let his service man fix him up RIGHT on the proper aerial.

Nominally 25c a copy, this valuable data may be had free by any service or dealer organization requesting same on its letterhead.

Write us at once, please.



Famous the world  
over for antenna  
supplies and high  
grade radio wire  
products

**CORNISH WIRE CO.**  
30 Church Street, New York City

in ohms and a recommended Electrad control for replacement purposes.

57. *How to Build a High-Quality Condenser or Ribbon Microphone.* The Amerpette Microphone Kit, with which it is possible to build, easily and quickly, a high-quality condenser or ribbon microphone.

60. *Transformers and Choke Coils for Use in Public-Address Amplifiers and Radio Receivers.* Information on the characteristics of a wide variety of Amer-Tran De-Luxe and standard audio and power transformers and chokes.

63. *Moderate Priced Transformers and Chokes.* Descriptions and prices on the new Amer-Tran line of moderate priced audio and power transformers and chokes designed for original and replacement use in radio receivers, amplifiers, public-address systems and amateur transmitters.

65. *New 1935 Line of Testing Instruments.* Information on the new 1935 line of Supreme testing instruments including the new 5" fan-shape meter, the new Model 333 deluxe analyzer, the low-priced Model 333 standard analyzer and an improved Model 85 tube tester.

66. *An A.C.-D.C. Tester Which Can Be Built at Home at Low Cost.* Information about the Supreme 5" fan-shape meter, rectifier and resistor kit for the home kit for the home construction of an inexpensive A.C.-D.C. tester.

## Education for Making a Living in Radio

(Continued from page 419)

the Candler System, for the following figures—with which, incidentally, the writer checks:

Considering the average student, it usually takes about 2½ months to develop from zero to ten words-per-minute—the requirement for an amateur license—with a couple of words-per-minute to spare. From ten to twenty-words-per-minute requires another two months, and perhaps seven weeks additional to climb to the thirty word-per-minute class. For still higher speeds the rate of gain slows and it may take another six months before the operator can copy thirty-five words-a-minute, with ease and confidence.

In the instances of students who find extreme difficulty in gaining speed, the trouble is probably due to bad habits—psychological and operating. Such students will find a correspondence course with the Candler System of considerable assistance. The lessons form a Code course, pure and simple, and are aimed at developing that automatic co-ordination of mind and muscle essential to expert operating. Several courses are available, depending upon the student's speed and experience.

The correspondence schools can be recommended to the diligent student as excellent training for a license. Broadcast transmitters, speech amplifiers, antennas, attenuation pads, control systems, general broadcasting technique and fundamental radio and electricity are thoroughly covered in such courses. By eliminating much of the service data, the student should be able to qualify for a license in six months. In some instances, arrangements may have to be made with the school, permitting the extirpation of certain parts of the course in an effort to speed up the acquisition of the coveted license.

Correspondence courses can be started at any time. The cost of correspondence training for Code operators averages around \$135.00. It may, of course, be pursued during one's spare time, and by the time the regular lessons are completed the student's code ability should be sufficient to pass him for a second grade license. The reader is referred to those correspondence schools whose advertisements are found regularly in RADIO NEWS. Most residence schools will accept new students the first of every week. The R.C.A. Institutes, a school founded in 1909, previously known as the Marconi School of Instruction, offers a complete course in commercial radio operating, including marine, aircraft, police and experimental radio operating, requiring twenty-six weeks of study in the Institute. (R.C.A. Institutes also has an extension course for home study including ten lessons of aviation, broadcasting, and marine operating.) The Capitol Radio Engineering Institute features a ten weeks' residence course in conjunction with their regular correspondence course which particularly fits the student for broadcast operating. The Dodge Institute conducts a nine months' course which comprises broadcast engineering, broadcast operating, radio servicing, and marine operating—the graduate being qualified for both radiotelegraph and radiotelephone license. However, this course can be modified to embrace only the subjects required for a radiotelephone license. Matriculation at the Dodge Institute is permitted only at quarterly class organizations. It is suggested that the prospective operator choose his school in accordance with the method of selection recommended in the first article of this series.

Before taking the government examination; the writer recommends that the operator have a 50 percent margin of safety. The fact that one can copy 20 words-per-minute at home does not mean that the performance can be duplicated under the mental strain of an examination. However, the operator who can honestly do 30 words-per-minute will hardly be bothered by 20, even under unfavorable conditions.

With the exception of the Commercial Extra First Class license (the holder of which can operate any class of station other than amateur) a radiotelephone license must be secured for the operation of a broadcasting station. As no Code tests are required for these licenses, the time of study in residence schools is cut about in half. However not all residence operating schools train for this type of license, such schools often being primarily directed toward the development of Code operators.

One's initial efforts in learning code are best made with a key and buzzer or oscillator, preferably hooked up so that headphones can be used. Mechanical transmitters such as the Instructograph, Teleplex and the Nacometer (which N. R. I. furnishes with their special operator's course) are of assistance (RCA Institutes also offer a code outfit by special arrangement). The Teleplex is particularly useful in that it retransmits your own sending, the defects of which may then become apparent in contrast with a professional "fist". Many commercial transmitters send repetitions of simple letter groups during extensive test periods, which usually form the first recognizable signals. Also, it is almost always possible to locate some station (with a short-wave receiver) sending slowly with each word repeated. Amateur stations, which are members of the Candler System Guild, transmit regular schedules at varying speeds for the benefit of student operators. As soon as you are qualified, own and operate your own amateur station. This is one of the most effective methods of gaining speed and of familiarizing one's



self with the technique of handling traffic.

Needless to say, self-training should be attempted only if the student is confident in his ability to teach himself. Several good books should be studied. The writer recommends "Practical Radio Telegraphy" and "Radio Operating Questions and Answers," by Nilson and Hornung, published by McGraw Hill, Robinson's "Manual of Radio Telegraphy and Telephony," published by the United States Naval Institute; "Principles of Radio" by Keith Henney, and "Principles of Radio Communication" by Morecroft—the last two books being published by John Wiley and Sons. The contents of the first two volumes should be mastered, the remaining books being used more as reference works and for the clearing up of obscure points. The length of time required for self-training depends upon the diligence of the student, the speed with which he develops proficiency in code, his natural qualifications and the grade of license for which he is shooting. The average self-trained student if he will really apply himself, should be able to pass the examination for Radiotelegraph Operator Third Class after 9 months' training, and Second Class after about a year. Examinations for higher grades can be taken only after experience has been gained with a lower grade license.

### The DX Corner (Broadcast Band)

(Continued from page 429)

only KSL. I found it very curious that only this station was audible, with no trace of other U. S. stations. Sweden seems to be in a good location for signals from the U. S. west Coast. Last winter I heard lots of small west coast stations.

"The South American stations, particularly Argentinians, Uruguayans, and the Bolivian station CP4 are always very well received here, quite as good in the summertime as in winter. Every morning between 1:00-5:00 a.m., I easily tune in lots of S. A. stations with great volume. The following are the best ones: LR6, LR4, LR5, LR3, LR8, LS8, LS2, and CP4. The new LR6 transmitter on 870 kc. comes over with R8 almost at all times."

### The "Ham" Shack

(Continued from page 417)

signed to match the output impedance of a pair of -45 type tubes and the input to the 210's, is mounted at the left. The sockets for the tubes are mounted 1 1/4 inches above the metal chassis and are located so that the grid leads from the input transformer lead directly to the grid connections on the sockets. On the right of the base is the output transformer. The connections from the plates of the tubes run directly to the primary of the output unit. The output of this particular transformer is designed for matching either a 5000- or a 10,000-ohm load, and therefore three terminals are provided. These are run to stand-off insulators. The high voltage terminals are brought to additional porcelain insulators on the side of the unit, and filament and C battery connections are standard binding posts.

The plate voltage supply unit for any Class B amplifier should be one providing good regulation. It is essential to employ a swinging choke, although it is not neces-

sary to use a smoothing choke when 4 or 5 mfd. of filter condenser are available. The transformer should be one capable of delivering at least 600 volts d.c. across the output of the filter circuit. With such an input, it is possible to obtain audio outputs of the order of 60 watts.

In putting the unit in operation, the "universal" speech amplifier should be tested first for audio quality. It then may be connected to the modulator. In adjusting the modulator for Class B operation, the C bias voltage should be increased until the plate current (without modulation) is between 10 and 20 milliamperes. Batteries should be used for C bias in the Class B modulator. Before applying plate voltage to the 210's, it is important to connect a load across the output terminals of the Class B amplifier. This will prevent the danger of a flashover between the turns in the secondary of the output transformer. This may be either the Class C radio-frequency amplifier connected in the normal manner or a 5000-ohm, 100-watt resistor.

The plate voltage should then be applied and the bias voltage adjusted until the plate current falls to between 10 and 20 milliamperes. The C voltage for the 210 type tubes used on the modulator described should be about 67 1/2 volts. It may be necessary to increase or decrease this value to some extent in order to obtain a low idling plate current. If tubes of a different type are employed, the voltage specified by the manufacture should be used as a starter and if the desired current is not obtained, adjustments then may be made. When modulation is applied the plate current of the Class B tubes of course will jump to about 140 to 180 milliamperes on peaks.

The output transformer used is designed to pass the Class C current up to 200 milliamperes, and therefore is adequate for modulating any Class C amplifier within the input range of the modulator output. Both the universal amplifier and the Class B modulator described in this department have been used at an Eastern station for three months, and excellent results have been obtained. Using a good grade double-button microphone, the quality reports from both distant and local stations have been excellent.

This department wishes to thank the many amateurs who have asked to become contact stations for the "Ham Shack." It would be impossible at this time to include a complete list of those who have made such requests, but those whose requests were received during the first week after the November issue of RADIO NEWS was distributed include: W1GWV, Andrew Woloschak, of Merrimac, Mass.; W8EBX, Norris Hathaway, of Adrian, Mich., and W7EDD, Howard James, of Bonners Ferry, Idaho.

### Calls Heard

By Edela Rosa, 25 Royal Road, San Fernando, Trinidad, B. W. I., on 20-meter phone: W2CCP, K4SA, W9USA.

By Millard H. Clary, Geneseo, Kansas, on 20-meter phone: W6KM, W3ME, W5BDB, W5HK, W3APO, W2HFS, W3MD, W9BEX, W2BYK, W3AUC and W2BRO.

By N. C. Smith and J. Parkinson, Forge House, High Street, Foor Cary, Sidcup, Kent, England, on 20-meter phone: LA1G, W9USA, W6BNU.

By P. Burwell, Globe Road, Clethorpes, Lincs, England, on 20-meter phone: W9USA, K4SA, W8GLY, W3QV, W2DC, W3APO, W2GC, W1UH, W6QD, W3ZX, VE2DX, W2AED, VE2EE, W2ADC, CM2RA, W2GOX, ZL2LB, LUIAD and K5AA.



"Since using your control I feel like a new radio" . . . "never performed better in my life," writes another.

and so it goes . . . thousands of old, worn out, tired radios are being rejuvenated by alert servicemen with **CENTRALAB** replacement units.

And remember you can do a better job with a smaller stock of controls if you stick to **CENTRALAB**



**Centralab**  
Division of Globe Union Mfg. Co.,  
Milwaukee

## HOW TO BUILD, TEST AND REPAIR RADIO SETS



### Radio Construction Library

Including Television, Short-Wave Receivers and Auto Radios, 3 Volumes, 5 1/2x8—1177 pages, 561 illustrations. This practical Library includes: **PRACTICAL RADIO**—The fundamental principles of radio, presented in an understandable manner. Illustrated with working diagrams. **PRACTICAL RADIO CONSTRUCTION AND REPAIR**—Methods of locating trouble and reception faults and making workmanlike repairs. Discusses modern Short-Wave Receivers and installation of automobile radios fully. **RADIO RECEIVING TUBES**—Principles underlying the operation of all vacuum tubes and their use in reception, remote control and precision measurements. Helps you to understand modern type receiving sets—full of construction data and practical kinks for the experimenter.

**10 Days Free Examination Easy Terms**

### FREE EXAMINATION COUPON

McGraw-Hill Book Company, Inc.  
330 West 42nd Street, New York

Send me the new **RADIO CONSTRUCTION LIBRARY**, three volumes for 10 days' free examination. If satisfactory I will send \$1.50 in ten days, and \$2.00 a month until \$7.50 has been paid. If not wanted I will return the books postpaid.

Name.....  
Home Address.....  
City and State.....  
Position.....  
Name of Company..... RN-1-35

## A hit! The 7-POINT MICROPHONE

Here's why the Amperite Velocity Microphone gives you the best in quality and value. . . . (1) Wider frequency range. No peaks; no distortion. (2) Directional quality makes it easy to eliminate feedback. (3) Wider area of coverage. One Amperite Vel. Mike will replace several diaphragm type mikes. (4) Not affected by temperature, weather conditions or age. (5) Rugged construction. (6) Best values in mikes, or money refunded. (7) Fully guaranteed for two years against any service costs. Order from your wholesaler.



AMPERITE Corporation 561 B'WAY N. Y. C.

## AMPERITE VELOCITY MICROPHONE

### SILVERED ETCHED METAL DIALS

Three types for models 301-88-321  
BUY THROUGH YOUR DEALER  
New Catalogue No. 7 just for a post card  
D. L. VAN Leuven, 410 E. 15th St., New York, N. Y.

**BROWNING**  
UNIVERSAL  
**All-Wave Antenna Kit**  
Radio's Greatest Value  
**RIVARD MFG. CO.**  
1014 Madison Ave. Toledo, Ohio

## The DX Corner (Short Waves)

(Continued from page 413)

Java, with a program from 5-11 a.m., E.S.T. (Reported owned by NIROM.)

A station reported by some listeners as COH, of Havana, Cuba, has been testing recently on 9428 kc. Other readers report it at 9438 kc. They have been heard from 8 to 10 p.m., E.S.T. Other listeners report this station as COA. The Westchester Listening Post observers state that sometimes it sound like COA and other times COH. Which is it?

Who knows the correct wavelength of OER2? Their communications state 6072 kc., but they have been reported heard higher in wavelength than OXY.

### W3XAU Transmissions

An official communication from the WCAU Broadcasting Co., in Philadelphia, states that W3XAU will be on the air, effective Monday, October 8th, from 12 noon to 8 p.m., 9590 kc., and from 8-11 p.m., E.S.T., on 6060 kc.

### TXG Transmission

An official communication from the Guatemala newspaper, *El Liberal Progresista*, states that radio station TXG transmits daily except Sundays, from 6-8 a.m., 11 a.m. to 12:30 p.m., and from 6-10 p.m., E.S.T., on a wavelength of 50.50 meters, 5937 kc. The power is 100 watts.

### British Empire Transmissions

An official communication from the British Broadcasting Corporation states that the Empire short-wave stations will transmit on a schedule shown in this month's Time-Table, but that GSB may be substituted for GSC, and GSD may be substituted for GSE, and vice versa.

### W9XAA Transmissions

An official communication from the Chicago Federation of Labor states that short-wave station W9XAA has a fixed schedule, on Sundays, from 9:30 a.m. to 7 p.m., E.S.T., transmitting on a frequency of 6080 kc. The station is on the air almost daily, but the schedule is irregular.

### HIX Transmission

An official communication from the Director of Radio Communications in the Dominican Republic informs us that short-wave station HIX is on the air Tuesdays and Fridays, beginning at 8:10 p.m., E.S.T., and Sundays from 7:40 a.m. The frequency is 6000 kc. and the power 200 watts.

### EAQ Transmissions

An official communication from "Radio-difusion Ibero-Americana" states that EAQ transmits on a wavelength of 30.43 meters, 9860 kc., with a power of 20 kw. The station broadcasts daily from 22.15 to 00, G.M.T., and on Saturdays from 18 to 20, G.M.T. The International Broadcasting Co., of London, transmits a special program over EAQ on Tuesdays, Thursdays, Saturdays, Sundays from 00 to 00:30, G.M.T.

### Radio Coloniale Transmissions

An official communication from station Radio-Coloniale states that the power of the station has remained the same and transmissions take place from 12:30 to 17, G.M.T. Since the 19th of July simultaneous transmissions have taken place on 25.2 meters and 19.6 meters, from 16:30 to 17:30, G.M.T.

### TIEP Transmissions

An official communication from La Voz del Tropico at San Jose, Costa Rica, states that their station will be on the air from 5-8 p.m., E.S.T., on a frequency of 6710 kc., 44.7 meters. After 8 p.m. it is the custom to have daily conversations with DX friends in different countries.

### HC2RL Transmissions

An official communication from the director of station HC2RL states that they will be on the air on Sundays from 5:45 p.m. to 7:45 p.m., E.S.T., and on Tuesdays from 9:15 p.m. to 11:15 p.m., E.S.T. The power is 150 watts. They begin and conclude the program with the Ecuadorian national anthem.

### I2RO Transmissions

An official communication from the E.I.A.R. at Rome states that the station I2RO will be on the air from 12:30 a.m. to 2 a.m., G.M.T. This program is transmitted on 48.70 meters or 6156 kc., with a power of 25 kw.

The new station at Prato Smeraldo can transmit on four distinct wavelengths: 48.7 meters, 42.98 meters, 31.13 meters, and 25.4 meters. Directional antennas are employed. There are also two omni-directional antennas on the 48.7- and 31.13-meter wavelengths. (Note: We have kept the old 25.4-meter schedule on the Time-Table.)

### German Transmissions

An official communication from the German short-wave stations states that they will follow a schedule as shown in this month's Best Bets.

### The DX Corner Grows Too Fast

The Editor is sorry that on account of lack of space this month, all of the thousands of reports received could not be written up separately. All the short-wave information out of every worthwhile report, however, has been incorporated in the World Short-Wave Time-Table or in the month's "partial information" listed under the heading, "Listening Post Observers and Other Fans, Please Note!"

### Readers Who Helped Log Stations for This Month's Report

We are indebted to the following readers of RADIO NEWS who furnished important information on their reports of short-wave reception this month: M. Mickelson, Minneapolis, Minn.; J. C. Braggio, Rio de Janeiro, Brazil; H. Van der Veen, Bandung, Java; Carl A. Johnson, Loomis, Nebraska; A. G. Baadsgaard, Ponoka, Alberta, Can.; A. Lopez, Caracas, Venezuela; W. E. Ivey, Fayetteville, Ark.; Charles A. Morrison, Bloomington, Ill.; Ray Rogers, Jr., Highland Park, Ill.; John Latta, Jr., Buffalo, N. Y.; Albert E. Emerson, Cleveland, O.; Chas. A. Steele, Port Arthur, Tex.; Felipe L. Saldana, Tlax, Mexico; E. Raymond, New Bedford, Mass.; Chester A. Joeger, San Antonio, Tex.; Guy R. Bigbee, Fort Benning, Georgia; James J. Kiggins, Lynchburg, Va.; Dr. F. C. Naegeli, Jackson, Wyo.; Samuel J. Emerson, Cleveland, O.; Max Horlick, Youngstown, O.; Donald W. Shields, Roseville, O.; Reeve Owen, Calhoun, Ga.; R. W. Peyton, Shreveport, La.; Geo. R. Johnson, Medford, Ore.; Ralph Thompson, Cowden, Ill.; Wm. Schumacher, Ellis, Kansas; Edmore Melanson, Albany, N. Y.; B. R. Boone, Seattle, Wash.; L. C. Styles, Ingatestone, Essex, England; Wm. Kochlein, N. Y. C.; Henry Spearing, Indianapolis, Ind.; Elmer Jackson, Joplin, Mo.; Rafael A. Munoz, Atlanta, Ga.; Stuart Walmsley, Los Angeles, Calif.; R. G. Summers, Buffalo, N. Y.; Robert L. Weber, W. McHenry, Ill.;

C. D. Hall, Chillicothe, O.; Stephen McNamara, Brooklyn, N. Y.; Geo. Illenberger, Iloilo, P. I.; J. E. Brooks, Montgomery, Ala.; Kenneth Dressler, Brooklyn, N. Y.; Edward C. Lips, Pittsburgh, Pa.; A. Wright, Brooklyn, N. Y.; Paul B. Frame, E. Boston, Mass.; R. S. Houghton, Abram, Lancashire, England; C. Arthur Matthews, Victoria, Australia; Howard Adams, Jr., Baltimore, Md.; Mrs. L. R. Ledbetter, Vicksburg, Miss.; Vernon Warde, Minneapolis, Minn.; C. H. Armstrong, Atlanta, Georgia; Theo. S. Robinson, Watervliet, N. Y.; C. H. Skatze, Delaware, O.; J. C. Kalmbach, Jr., Buffalo, N. Y.; C. H. Day, Argentine Republic; Jack Bews, Vancouver, B. C., Can.; Robert Edkins, Transcona, Man., Can.; Robert G. Kiebach, Philadelphia, Pa.; Geo. Sholin, San Francisco, Calif.; James T. Spalding, Louisville, Ky.; Baron von Huene, Tientsin, China; Virgil Scott, Rockland, O.; H. Kemp, Waterbury, Conn.; Kenneth R. Boord, Smithfield, W. Va.; G. W. Twomey, M.D., Fort Snelling, Minn.; Wm. Dixon, Plainfield, N. J.; John McCarter, Decatur, Ga.; Ernest R. C. Flynn, Los Angeles, Calif.; Phil Robinson, Shelburne, N. S., Can.; George Nelson, Essex Fells, N. J.; Douglas S. Catchim, Washington, D. C.; N. C. Smith, Sidcup, Kent, England; Wm. S. Robinson, Sarepta, La.; Clifford Pryor, San Francisco, Calif.; Dr. E. Villar, Havana, Cuba; Duncan T. Donaldson, Kelty, Fife, Scotland; Gilbert L. Harris, N. Adams, Mass.; W. B. Ewing, Wheeling, W. Va.; Lawrence Swenson, Eden, Idaho; J. T. Atkinson, Minnedosa, Man., Can.; Arthur Hamilton, Somerville, Mass.; Edw. F. Bahan, Greenville, S. C.; Carl P. Peters, Troy, O.; Edela Rosa, Trinidad, B. W. I.; G. Hampton Allison, Emory, Va.; Charles Nick, Philadelphia, Pa.; R. Lawton, Whitefield, England; C. W. Bourne, Council Grove, Kans.; Earl G. DeHaven, Los Angeles, Calif.; Raymond H. Leeson, Auburn, N. Y.; Lewis F. Miller, Chicago, Ill.; Bruce T. McCoun, N. Y. C.; Heinie Johnson, Big Spring, Texas; Alfred G. Rogers, San Francisco, Calif.; Freeman C. Balph, Indianapolis, Ind.; Thursten Clarke, Pembroke, Bermuda.

### The Service Bench

(Continued from page 437)

eliminator for the standard automobile radio receiving sets. A list of replacement



parts and information for installing and servicing the eliminators is included. Through a special arrangement, these manuals are made available free to Radio Servicemen and Dealer readers of RADIO

NEWS. The only requirement is that all requests be written to us on letterheads indicating that the reader is a Radio Serviceman or a Dealer. Address requests to Department Y, RADIO NEWS, 461—8th Avenue, New York City.

### How to Modernize Your Analyzer

Through the courtesy of Mr. F. L. Sprayberry, RADIO NEWS is enabled to offer, free of charge, complete data sheets

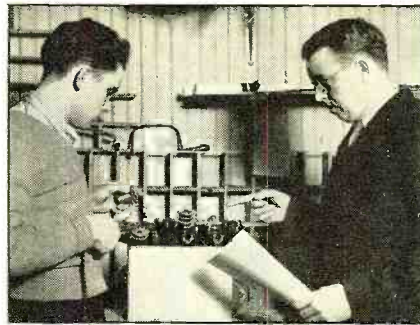

showing how to modernize the Jewell Model 199 and Supreme Model 400-B analyzers, bringing them completely up-to-date. Simply send in your requests to RADIO NEWS, Department RS, 461 Eighth Avenue, New York, and the pamphlet will be sent to you, gratis.

### “Acorn” Tube

(Continued from page 420)

indispensable for application to work in the 2½-meter and lower wavebands.

Just as other receiving tubes are used in transmitters by amateurs, the 955 may be so applied, despite the fact that it is not especially designed for transmission purposes. When used in a transmitter, though, sufficient power output is usually available to cover the average “line-of-sight” distances spanned by ultra-short-wave transmissions.

Characteristics of the 955 are as follows: Heater voltage, 6.3 volts; heater current, .16 amp.; maximum plate current, 4.5 milliamps.; mutual conductance, 2000 micromhos; maximum plate voltage, 180 volts; grid voltage, 5 volts; amplification factor, 25; plate resistance, 12,500 ohms.

### Modulation Tester

(Continued from page 421)

modulation is indicated when the deflection reaches the outer lines which are red. A negative 100 percent modulation is denoted when the center red line is reached. Bright spots on the center line which are caused by overlapping reveal a negative over-modulation.

With the pattern adjusted for normal brilliance, the modulation percentage can be read as much as twenty feet away from the instrument in an average illuminated room.

In order to prevent deflection of the spot by external fields, the tube is doubly shielded. The electron gun is triply shielded. An adjustable, built-in magnet serves to compensate for the effects of the earth's magnetic field.

The 904 cathode-ray tube is used with the equipment. The “spot” of the tube is of small size and yields greater illumination.

# Sweeping THE FIELD

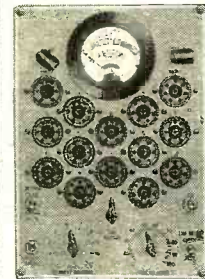

THE WESTON  
TUBE CHECKER  
MODEL 682  
**\$ 29.25** NET  
IN THE U. S. A.  
—with either portable or counter case

Priced sensationally low for a Weston quality tube checker, Model 682 is sweeping the field. Has every feature to make this a truly modern tube checker and merchandiser. Attractively finished in colors . . . scale with a “good-tube” area . . . spare sockets. Furnished with either counter or portable carrying case. Send coupon below for data.



THE WESTON  
SELECTIVE  
SET SERVICER  
MODEL 698  
**\$ 34.50** NET  
IN THE U. S. A.

Another bulls-eye! A Weston Set Servicer employing the Weston Method of Selective Analysis which banished servicer obsolescence. At a price everyone can afford. Furnished complete at this low price —including the improved Weston Socket Selector Set, leads, carrying case, instructions, etc. Return coupon for bulletins.

## WESTON Radio Instruments

Weston Electrical Instrument Corporation,  
615 Frelinghuysen Avenue, Newark, N. J.

Send bulletin on Weston Model 682 Tube Checker and Model 698 Selective Set Servicer.

Name.....

Address.....

City..... State.....

# RADIO NEWS INDEX

VOLUME XVI

July, 1934

NUMBER 1

Holiday Listeners.....	William C. Gittinger.....	Page 8
Portable Radio for Car or Boat.....	By the Staff.....	Page 10
110-Volt A.C. Supply Unit.....	Nat Pomeranz.....	Page 12
Fifteenth Anniversary Radio News.....	Historic Resume.....	Page 13
World Distance Map (Eastern U. S.).....	By the Staff.....	Page 19
Listening to Byrd.....	Samuel Kaufman.....	Page 20
How to Build a 2-Tube Short-Wave Set.....	Harry D. Hooten.....	Page 23
Getting Acquainted with Short Waves (Part Seven).....	James Millen.....	Page 24
A 2-Stage T.R.F. Preselector.....	B. J. Montiny.....	Page 26
Latest All-Wave and Short-Wave Receivers.....	Wm. C. Dorf.....	Page 27
Practical Amateur Aerial Design.....	A. H. Lynch and E. Glaser.....	Page 28
Phenomena Underlying Radio (Part Eight).....	E. B. Kirk.....	Page 30
Data on the 6C6-6D6 Tubes.....	J. van Lienden.....	Page 31
Radio News Portable Tube Checker.....	John H. Potts.....	Page 32
Station List—Europe.....	By the Staff.....	Page 36

VOLUME XVI

August, 1934

NUMBER 2

Big New Things in Radio.....	Wm. C. Dorf.....	Page 72
If Not "Television" Why Not "Facsimile".....	Laurence M. Cockaday.....	Page 76
Radio News Universal Multimeter (Part One).....	John H. Potts.....	Page 78
Electronics in Checking Timepieces.....	Frederic Siemens.....	Page 80
A Combination Hearing-Aid Radio.....	Samuel B. Simer.....	Page 81
Notes on R.F. Amplifiers (Part Three).....	Edward M. Glaser.....	Page 83
S.W. Station List (Part One).....	By the Staff.....	Page 85
World Distance Map (West Coast).....	E. J. Quimby.....	Page 91
A Compact S. W. Receiver.....	Technical Editor.....	Page 93
How to Build the Radio News "Dragnet".....	S. Gordon Taylor.....	Page 94
Getting Acquainted with Short Waves (Part Eight).....	James Millen.....	Page 96
Rating Tests on Receivers.....	J. W. Fulmer.....	Page 98
Making Any Set "All Wave".....	Technical Staff.....	Page 98
Two New S.W. Sets.....	By the Staff.....	Page 99
All-Wave Set Design (Part One).....	McMurdo Silver.....	Page 100
A Visual Volume Control.....	Samuel Kaufman.....	Page 102
A Remote Control Receiver.....	Technical Staff.....	Page 116

VOLUME XVI

September, 1934

NUMBER 3

The First Telecommunication Convention.....	Gerald C. Gross.....	Page 136
World Distance Map (Europe).....	John Borst.....	Page 144
Short Wave Station List (Part Two).....	By the Staff.....	Page 145
The "All-Star" All Wave Receiver.....	Laurence M. Cockaday.....	Page 146
The "Double-Doublet" Antenna.....	W. H. Bohlke.....	Page 148
A Scouts "Own" S.W. Set.....	Laurence M. Cockaday.....	Page 150
All-Wave Set Design (Part Two).....	McMurdo Silver.....	Page 153
Tiny Transceivers in 5-meter Tests.....	S. Gordon Taylor.....	Page 154
Antenna and Feeder Design (Part One).....	Verne V. Gunsolley.....	Page 156
Phenomena Underlying Radio (Part Nine).....	E. B. Kirk.....	Page 157
A Powerful 30-Watt P. O. System.....	W. F. Marsh.....	Page 160
New Things in Radio.....	Wm. C. Dorf.....	Page 161
Radio News Universal Multimeter (Part Two).....	John H. Potts.....	Page 162
A Point-to-Point Analyzer.....	Emile Milles.....	Page 164
Data on the Type 18 Tube.....	J. van Lienden.....	Page 166

VOLUME XVI

October, 1934

NUMBER 4

"Our Own" Radio Show.....	Technical Staff.....	Page 200
A 12.8-550 Meter Superheterodyne.....	McMurdo Silver.....	Page 205
A High-Fidelity "LAB" Amplifier.....	J. M. Hollywood and M. P. Wilder.....	Page 206
History and Analysis of Receiver Controls.....	Paul G. Andres.....	Page 208
A New "All-Method" Analyzer.....	John H. Potts.....	Page 210
Some Practical "Band Spread" Methods.....	Alonzo Wierenga.....	Page 212
The "Ham" Shack.....	Everett M. Walker.....	Page 214
Antenna and Feeder Design (Part Two).....	Verne Gunsolley.....	Page 215
A Compact Amateur 5-Meter Transceiver.....	Edward M. Glaser.....	Page 217
French Broadcasting.....	Kurt Lang.....	Page 219
How to Build an A.C.-D.C. Midget.....	George Day.....	Page 222
World Distance Map (South American).....	John M. Borst.....	Page 230
Short-Wave Station List (Part Three).....	By the Staff.....	Page 231
The German Short-Wave Transmissions.....	W. W. Dieffenbach.....	Page 232
Operating Data on the "All-Star" Receiver.....	Laurence M. Cockaday.....	Page 235
A New 3-Band "Super".....	Technical Editor.....	Page 236

VOLUME XVI

November, 1934

NUMBER 5

Fliers! Here's How.....	Charles E. Planck.....	Page 272
The Radio Man Who Directs Aerial Traffic.....	Gilbert Princell.....	Page 273
Exploring the Playground of Radio Waves.....	Samuel Kaufman.....	Page 275
A 100-2100 KC. Signal Generator.....	S. Egert and S. Bagno.....	Page 278
British Lilliput Tubes.....	R. W. Hallows.....	Page 279
First Aid to Inventors.....	E. E. Free, Ph.D.....	Page 280
A High-Fidelity Laboratory Amplifier (Part Two).....	J. M. Hollywood and M. P. Wilder.....	Page 282
Some New and Useful Switches.....	Paul G. Andres.....	Page 285
A New S.W. Converter.....	By the Staff.....	Page 295
Build this "Skyscraper" S.W. Receiver.....	D. Pollack and S. G. Taylor.....	Page 296
A 9-240-9-2400-Meter Superheterodyne.....	By the Staff.....	Page 299
A New 6-Tube All-Wave Super.....	John Strong.....	Page 300
Short-Wave and Aviation Station Lists (Part Four).....	By the Staff.....	Page 301
A 12.8-550 Meter Superheterodyne (Part Two).....	McMurdo Silver.....	Page 302

VOLUME XVI

December, 1934

NUMBER 6

First Aid to Inventors (Part Two).....	E. E. Free, Ph.D.....	Page 336
Education for "Making a Living in Radio" (Part One).....	Zeh Bouck.....	Page 338
Radio in Aircraft (Part One).....	Henry W. Roberts.....	Page 340
Analyzer Modernizing.....	E. J. Sampson.....	Page 342
A High-Fidelity Laboratory Amplifier (Part Three).....	S. Gordon Taylor.....	Page 344
A Push-Pull Amplifier.....	Hubert Shortt.....	Page 346
Antenna Mechanics.....	Ray Hawksley.....	Page 348
Locations of Short-Wave Stations (Including Frequency and Wavelength).....	By the Staff.....	Page 356
Testing an All-Wave "Super".....	By the Staff.....	Page 358
Short-Wave Station List (Police and Television Stations).....	By the Staff.....	Page 359
The "Skyscraper" 3-Tube S.W. Set (Part Two).....	D. Pollack and S. G. Taylor.....	Page 360

**HOME CHARGE**  
Your Battery  
for a NICKEL  
with the New Hi-Rate  
10 to 15 Amperes AUTOMATIC  
**HOMCHARGER**



PLUGS in any lamp socket. Charges any auto-type battery overnight. Creates no radio interference. Uses no expensive bulbs, "dry units" or messy liquids. Has only ONE moving part, replaceable for \$1.00, after thousands of hours' use. The FASTEST, most EFFICIENT and LONGEST-LIVED home charger made. Ideal for Battery Station, Garage, Trucks, etc. Money-back guarantee. Nearly one million sold since 1920 at \$19.50 list. Now, only \$16.95 postpaid (or at your dealer). (New, er), complete with ammeter, 10-foot cables, dash plug, etc. Write for introductory proposition and FREE booklet. (Commission Salesmen Wanted).  
THE AUTOMATIC ELECTRICAL DEVICES CO.  
Dept. 6 324 East Third Street,  
Cincinnati, Ohio

**A.C. CURRENT-ANYWHERE!**  
WITH KATO LIGHT PLANTS



A Little Gas and a Kato AC plant enable you to operate AC radios, amplifiers, refrigerators and all other standard household appliances. Sizes 300 watts and up. Write for interesting descriptive literature.  
KATO ENGINEERING CO. Mankato, Minn., U. S. A.  
Mfgs of AC Generators and Converters for operating AC Radios on 85 and 110 volt DC.

## For A Prosperous New Year

Assure yourself of more profit and more entertainment from the field of radio during the year 1935 by making absolutely certain that you keep apace with every new development as it springs into being.

### Subscribe for RADIO NEWS

The best way to do this is to read RADIO NEWS each month. To assure the prompt receipt of each copy we suggest that you send \$1 with the coupon below and receive the next 5 issues of RADIO NEWS in addition to getting a copy of our new 136-page RADIO DATA BOOK absolutely free!

### Get a Free Copy of THE RADIO DATA BOOK

The new RADIO DATA BOOK will prove a tremendous asset to you during the coming year. Its features include Short-Wave First Aids, Antenna Systems, S. W. Adapters and Converters, Tested Short-Wave Receivers, Midget Broadcast-Band Receivers, Ultra-Short-Wave Amateur Equipment, Microphones, Servicing Apparatus and Station Lists. Get your free copy now!

## RADIO NEWS

Mail This Coupon Now!

RADIO NEWS, Dept. 351  
461 Eighth Avenue, New York, N. Y.

Enclosed find \$1 for which kindly send me the next 5 issues of RADIO NEWS and my free copy of the RADIO DATA BOOK. (Canada \$1.25—Foreign \$1.50).

Name.....  
Address.....  
City..... State.....

## Aircraft Radio

(Continued from page 423)

should be bonded at intervals of not less than 36 inches (preferably less), and also at the ends. All rubbing contacts must be insulated or bonded.

Wooden wings are bonded in the following manner. Run a metal strip along each spar (a 1/4-inch strip of 1/8-inch brass will do very nicely), and attach it to the spar with small brass screws or brads, being careful not to damage or weaken the spar. If brads are used, dip them in resin, to prevent their working loose because of vibration. To these metal strips bond all tie-rods, brace wires and metal fittings inside the wing, bond the two strips together at the wing tip, and bond each to the metal fuselage. Wooden fuselages are very rare now, but one may be bonded by attaching similar brass strips along each longeron, and bonding to them all metal parts inside the fuselage. The strips are then bonded together, and to the wing bonding strips, forming one continuous whole.

Metal wings and metal fuselages are usually satisfactorily bonded at the time of construction, and need only be checked and tested. The control surfaces, after being bonded internally (if necessary), are then connected electrically to the main metal structure of the airplane, and the control cables are by-passed at the control horns and at all articulating joints by short lengths of bonding braid (see Figure 6).

Gasoline and oil tanks are, normally, already bonded to the metal structure, to reduce fire hazard when fueling; they should, nevertheless, be checked for resistance. All gasoline and oil lines must be securely bonded, and all rubber-hose connections by-passed by bonding braid, to which the metal clips holding the rubber hose in place should also be bonded.

All brace wires and tie-rods are also bonded to the structure, and checked for resistance, as their terminals frequently offer considerable resistance to high-frequency currents. Where the resistance is found to be too great, by-pass the terminals by bonding. All rubbing or vibrating contacts between brace wires, and between control cables and structural parts of the airplane, must be insulated. Micarta spacers, wrapped with tape, will answer the purpose in the majority of cases.

All shielding must be bonded at frequent intervals, not less than 20 inches. The engine shielding must also be bonded, and here conveniently located clips form both a bond and a support. When using clips, scrape the metal clean and bright, and after the clip has been set in place, apply paint or other protective covering. All contact surfaces in the airplane structure should be treated in this manner.

It is always well to bond the engine to the engine mount, by-passing at the attachment bolts, especially if the engine is mounted in rubber shock absorbers. With wooden instrument boards, it is necessary to interconnect all metal instrument cases, bonding the whole to both sides of the fuselage. With metal instrument boards (usually mounted in rubber) it may be sufficient to bond the board only.

While the efficiency of the shielding job can best be tested only in flight, the bonding is best tested on the ground. Any circuit testing method will do, but the following two are suggested. Connect in series a 2-volt storage battery, a low-resistance rheostat, and a low-scale ammeter (say, 0 to 2 amperes), using copper wire

## WHEN CHOOSING A RADIO SCHOOL

RCA Institutes, with its reputation firmly established by 25 years service is an institution recognized as an important factor in the radio industry.

Whether elementary radio principles or advanced subjects, sound applications, mathematics or practical radio engineering, RCA Institutes is prepared to give you the instruction you need.

### Resident Schools at New York and Chicago

Modern Apparatus and Laboratory Equipment—Conveniently Located—Day and Evening Classes—Tuition Rates \$3 to \$10 Weekly.

### Extension courses for home study

on convenient "no obligation" plan. Examination and technical advisory services. Free post-graduate practical training at resident school with modern equipment under instructing engineers.

Write for Catalog.

## RCA INSTITUTES, Inc.

Dept. RN-35

75 Varick Street  
NEW YORK

1154 Merchandise Mart  
CHICAGO

Recognized Standard in Radio Instruction Since 1909

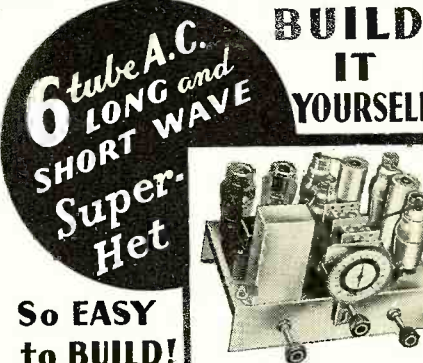

**6 tube A.C. LONG and SHORT WAVE Super-Het**

**BUILD IT YOURSELF**

**So EASY to BUILD!**

All you need is a screw driver, pliers and soldering iron to build this new Tru-test 6-tube A.C. Long and Short Wave Superhet. It's so easy to build from our detailed easy to follow diagram and wiring instructions. Even the novice will get results the first time.

**And what results!**  
This remarkable "skip band" superhet takes in not only the entire broadcast band from 200-550 meters but important foreign stations from 17.6 to 50 meters.  
No. Y22012—Complete kit of parts for 6-Tube "skip band", less tubes and speaker.....\$16.50

### FREE 1935 CATALOG

192 Pages packed from cover to cover with over 50,000 items. The Greatest Radio Catalog ever printed. Contains Big Specialized Short Wave Department where practically every leading manufacturer is represented. Hundreds of Bargains—everything at Lowest WHOLESALE Prices!

## WHOLESALE RADIO SERVICE CO., INC.

NEW YORK | NEWARK | ATLANTA  
100 Sixth Ave. | 219 Central Ave. | 430 W. Peachtree St. N.W.

Department N-15

- ( ) Send me your FREE 1935 Catalog of 192 pages.
- ( ) Send me the order on 6-tube "Skip Band" I have described in letter.

Name.....  
Address.....  
City..... State.....

# Why Not Get Everything!

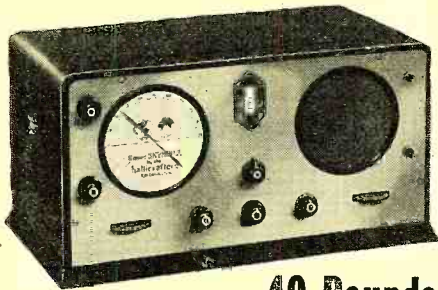

## 40 Pounds of Short-Wave Dynamite The New SUPER SKYRIDER

The HALLICTRAFTERS do not guarantee you round-the-world reception alone. Instead we want you to ask about the STRENGTH, TRUE TONE, and FREEDOM FROM NOISE when Europe, Australia, Japan, and Africa are received.

The 1935 HALLICTRAFTERS SUPER SKY-RIDER has left far behind the days of tiresome fishing for faint signals amidst deafening noise blamed on static, but in reality caused by unrefined set design. Let these features tell you how this totally new performance is secured:

PRE-SELECTOR STAGE	BUILT-IN DYNAMIC SPEAKER
CONTINUOUS BAND-SPREAD	BUILT-IN POWER SUPPLY
TRUE SINGLE DIAL OPERATION	AIR-TUNED I.F. TRANSFORMERS
ACCURATE LOGGING	NEW NOISE-FREE 6 V. TUBES
NO PLUG-IN COILS	NEW TONE AND VOLUME CONTROLS
BROAD NOTE OSCILLATOR	FREQUENCY METER and STAGES
HIGH FIDELITY AUDIO	MONITOR

—and then there are countless other features described fully in the new FREE Bulletin.

**FOR ACTION—Write Today!**  
**hallicrafters, Inc.**

Dept. B—3001 Southport Ave.—Chicago, U.S.A.

Send at once full data on the new SUPER SKY-RIDER.

Name.....

Address.....

**For Quick Service!**

★ CONTINUOUS BAND-SPREAD ★

**ALL-STAR** Complete Foundation Kits Only \$2.50

**ALL-WAVE Superheterodyne**

**Write CHI-RAD First!**

The ALL STAR FOUNDATION includes drilled base, Graydo front panel, enlarged schematic and wiring diagrams and detailed instructions for building, complete, only \$2.50. Send your order to CHI-RAD for quick action. FREE wiring diagram and parts list. WRITE TODAY!

**NEW NATIONAL De Luxe SUPER AND ALL SHORT WAVE RECEIVERS**

**SPECIAL—PLATE AND FIL. TRANSFORMER THORDARSON T-3773—\$1.85**

SEC. No. 1—1110 volts, 150 m.a.  
SEC. No. 2—5 volts c.t., 3 amps.  
SEC. No. 3—7.5 volts c.t., 2.5 amps.  
SEC. No. 4—2.5 volts c.t., 5 amps.

Send for FREE BULLETIN

**Chicago Radio Apparatus Co.**  
415 S. Dearborn St. Dept. RN-5 Chicago, Ill.

**AUTOMOBILE COMPASS**

Have you ever taken the wrong road and traveled many miles before discovering your mistake? This new AIR-PLANE TYPE COMPASS constantly tells your direction of travel. Sticks to windshield. Base 1 1/2" diameter. ONLY \$1.95 POSTPAID, including Compensator. SATISFACTION GUARANTEED or your money refunded if returned within ten days.

AGENTS WANTED!  
HULL MFG. CO., Box 246-K1, WARREN, O.

**LEARN RADIO THEORY AND PRACTICE**

At a liberally endowed and well established trade school. Founded in 1907. Practical shop instruction. Tuition fee \$45.00 per year. Free catalogue sent on request. Enroll now.

**THE DAVID RANKEN, JR., SCHOOL OF MECHANICAL TRADES**  
ney, Newstead and Cook Aves., St. Louis, Mo.

not thinner than No. 14. Adjust the rheostat to read 1 ampere with the test leads short-circuited. Now test the resistance of various parts of the airplane with the test leads. A drop in current greater than 10% (ammeter reading less than 0.9 amperes) indicates a faulty bond. Another method is to use a battery-operated buzzer using less than 10 volts, connected in a similar manner. If the buzzing is intermittent or absent, it indicates that the bonding connection is unsatisfactory. Make sure that all bonding connections and all joints in the metal framework are tested. Welded joints usually have low resistance, but sometimes a welded joint has to be by-passed. In such cases, mark the joint and notify the owner, as this may be an indication that the weld is structurally defective!

A few pertinent remarks on actual operating practice will conclude our discussion of this extremely important phase of aircraft radio installation and service. Handle the shielding harness gently, being careful not to break or damage the metal covering. It can be bent to astonishingly small radii, provided that the operation is done carefully and gradually. After installing, make sure that all joints are tight and that moisture cannot penetrate to the cables. In installing individual lead type harness, it is best to pass the cables through a metal tube, curved to fit and securely attached behind the engine; each individual pair of leads is then passed through a suitable opening cut in the tube wall, and then to the spark plugs. When cutting flexible conduit, care must be taken to prevent raveling of the metal braids at the cut. The conduit braid should first be sweated with solder, to hold the threads together at the cut; the sweated part should be about 1/2 inch wide, or 1/4 inch on each side of the cut. Instead, the conduit may be taped, and the cut made through the tape, but this method is less satisfactory. The cut should be made at exactly the right angles, and for this purpose a simple cutting jig, made of two blocks of wood hollowed half-round to hold the conduit, and having a saw guide at the top, can be used to good advantage. If ferrules are to be put at the ends of the conduit, a swaging tool (Figure 7) permits affixing them securely without the use of solder, and should be used.

It is necessary to use only non-corrosive solder in all soldering operations. Resin-core radio solder will answer the purpose in most cases, but should not be used in soldering to steel. Soldering with non-corrosive flux can be resorted to in such cases, but the surface must be carefully and thoroughly wiped after each operation. Avoid soldering to brace wires and control cables, as the heat required for soldering is likely to damage the metal, endangering the fliers! Control cables are best bonded by placing a wide braid on the control wires near the thimble and wrapping with waxed and shellacked cord, the other end of the braid being then pigtailed to a good "ground" contact. Under no circumstances do any soldering on shielding harness containing cables; the cables must first be removed!

When going about the installation, do not cut fabric or drill any structural member of the airplane without consulting the airplane mechanic in charge of the ship. You may unwittingly cause considerable damage. The average airplane mechanic knows little about radio, and a friendly exchange of information on your respective work will result in a better installation and better maintenance of the radio after your job is finished.

An airplane is usually checked every 20 hours of flying time, top-overhauled every 100 hours, and major-overhauled every

**SEND FOR THIS FREE CATALOG**

100 pages chock full of BARGAINS in RADIO SETS, Long and Short Wave Apparatus, Servicemen's Repair and Replacement Parts, Electrical Appliances and hundreds of miscellaneous Specials at TREMENDOUS SAVINGS. Get this big new Bargain Book. It's absolutely FREE without obligation—just send us your Name and Address on a post card.

**Write for Your Copy Now**

**JUST OFF THE PRESS**  
RADIO CIRCULAR CO., INC.  
225 Varick St., Dept. R.N., New York, N. Y.

**Read Classified Advertising—It Pays**

Advertisements in this section twenty cents a word for each insertion. Name and address must be included at the above rate. Cash should accompany all classified advertisements unless placed by an accredited advertising agency. No advertisements for less than 10 words accepted. Objectionable or misleading advertisements not accepted. Advertisements for these columns should reach us not later than 3rd of 2nd month preceding issue.

**TECK PUBLICATIONS, INC.**  
461 Eighth Ave. New York, N. Y.

**Agents Wanted**

AGENTS: Stick-on-Window Sign Letters. 500% profit. Write today. Metallic Letter Co., 422 N. Clark, Chicago

**Correspondence Courses**

USED Correspondence Courses and Educational Books sold or rented. Inexpensive. Money-back guarantee. Write for Free Catalog listing 4000 bargains. (Courses Bought.) Lee Mountain, Pisgah, Alabama.

**Instruction**

GET A U. S. Government Job commence \$105-\$200 month. Men, women, age 18-58. Are you eligible for examination? Get our Free Questionnaire—find out. No obligations whatever. Instruction Bureau, Dept. 251, St. Louis, Mo.

**Patent Attorneys**

PATENTS. Instruction "How to Establish Your Rights" and form, "Evidence of Conception"—sent Free! Lancaster, Allwine & Rommel, 414 Bowen Building, Washington, D. C.

PATENTS—Advice and booklet free. Highest references. Best results. Promptness assured. Watson E. Coleman, Patent Lawyer, 724 9th Street, Washington, D. C.

**Patents and Inventions**

INVENTIONS COMMERCIALIZED. Patented or unpatented. Write Adam Fisher Company, 278 Enright, St. Louis, Missouri.

**Radio**

RADIO ENGINEERING, broadcasting, aviation and police radio, servicing, marine and Morse telegraphy taught thoroughly. All expenses low. Catalog free. Dodge's Institute, Elm St., Valparaiso, Ind.

GOVERNMENT gives free Radio Operators' training for service on aircraft, ships. Salary, expenses paid. Information booklet, how to qualify, apply, 20c. Continental, Box 344V, Indianapolis, Ind.

**Salesmen Wanted**

WANTED: County Salesman with car, to demonstrate and service for large Ohio manufacturer. First-Class job. 242 Fyr-Fyter Co., Dayton, Ohio.

**Song Poems Wanted**

WANTED: Original poems, songs. MDM Publishers, Studio Building, Portland, Ore.

# TRI-STATE COLLEGE

## Radio Engineering

**Degree in 2 Years**

Complete Radio Engineering course in 96 weeks. Bachelor of Science Degree. Radio (television, talking pictures and the vast electronic field) offers unusual opportunities for trained radio engineers. Courses also in Civil, Electrical, Mechanical, Chemical, Aeronautical, Architectural Engineering; Business Administration and Accounting. Low tuition, low living costs. World famous for technical two-year courses. Those who lack high school may make up work. Students from all parts of the world. Located in picturesque hill and lake region of northern Indiana. Enter September, January, March, June. Write for catalog.

1615 COLLEGE AVE. ANGOLA, IND.



**SOLAR**

WET AND DRY ELECTROLYTIC PAPER AND MICA CONDENSERS

RECOGNIZED FOR SUPERIOR QUALITY IN ALL CLIMATES THE WORLD OVER

SOLD BY LEADING JOBBERS EVERYWHERE

SOLAR MFG. CORP. 599 BROADWAY NEW YORK

**BEST BY TEST!**

ASK FOR CATALOG OF EXTREMELY COMPACT TYPES HANDY FOR SERVICE

# READ AND SEND CODE

Learn Easily At Home This Quicker Way

No experience needed. Beginners read code quickly, copy accurately. If already an op, speed up your work with this approved amazing New Master Teleplex. Only instrument ever produced which records your sending in visible dots and dashes—then sends back to you audibly through headphones. Fascinating, fool-proof gets results because you learn by HEARING as well as seeing. Teleplex has taught the code to more students in past few years than all other systems combined. Used by U. S. Army and Navy, R. C. A. T., & T., and others. We furnish Complete Course, lend you the New Master Teleplex, and give you personal instruction with a MONEY-BACK GUARANTEE. Low cost, easy terms. Write today for folder R.N.-25, no obligation.

**TELEPLEX COMPANY**  
76 Cortlandt St.  
New York, N. Y.

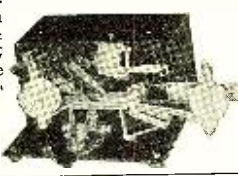

# ANTENNAE FOR ALL WAVES

BUILT READY-TO-HANG-UP. LYNCH materials used exclusively. For suggestions and estimate; send sketch of location.

Illustrated: LYNCH HI-FI Duplex Cage, Giant Killer lead-in ALL WAVE Antenna System complete \$13.75.

**AMPLIVOX LABORATORIES** 227 Fulton St. New York City

# CORONA HOTEL

Ste. Catherine and Guy Sts.  
**MONTREAL, CANADA**  
(Next door to His Majesty's Theatre)

**RATES:**  
Single, from \$1.50 Double, from \$2.00  
Suites from \$4.00

**GEO. V. GREEN, Managing Director**

# LEARN IN LOS ANGELES

## Radio-Television

ELECTRICITY—TALKING PICTURES BROADCASTING—Special Limited offer!  
GOOD JOBS WON BY TRAINED MEN  
R. R. coach fare allowed to L.A. Earn living while learning. 30,000 graduates. Latest facilities. No dummy equipment. Free employment service. Est. 29 Yrs. Send for FREE Illustration Catalog. Tells how to earn good pay.  
**NATIONAL RADIO & ELECTRICAL SCHOOL**  
Dept. 1-RN, 4006 S. Figueroa Los Angeles, Calif.

250 hours or so. This will coincide comfortably with the necessary radio check-up, servicing, and replacement of parts, and you should make arrangements to be advised when the ship goes up for overhaul so that you can check the radio installation periodically.

Most of your revenue will be derived from service work; and most of your service work will deal with shielding and bonding. It will, therefore, be to your advantage to become thoroughly familiar with this important branch of aircraft radio.

# Aid to Inventors

(Continued from page 405)

formal requirement of a patentable invention is operability. If the Patent Office Examiner suspects that your invention will not work, he may require you to prove that it will, by working models or otherwise. A special instance of this is perpetual motion, meaning some machine which will keep running forever without needing any power or which will yield more power than is put into it. For years so many inventors kept bothering the Patent Office by insisting on patents for such devices that the Office finally suffered almost the only attack of nerves in its history and issued a somewhat vitriolic statement that thereafter no application for patent on any kind of perpetual motion machine would be considered until the inventor had submitted a working model. The number of such applications promptly fell off to zero.

Still another of the formal requirements is that one application shall deal with only one invention. Should the Patent Office examiner decide that an application really involves two or more separable inventions, it is a frequent custom to require the division of the application into separate ones for each invention. This involves no disadvantage to the inventor except that he must pay a full set of fees for each application and patent.

The search made by the Patent Office for previous inventions is extremely thorough so far as previous United States patents are concerned. It usually is much less thorough in text books, scientific periodicals, foreign patents and other technical literature; which is one reason why anticipations of an invention not discovered by the Patent Office so often turn up later if the patent is attacked in court.

This is one reason, also, for the practice of most patent attorneys to make a private search of previous patents and some other literature before the application is filed. Another advantage is that the attorney then knows, before he files the application, which previous patents are closest to the invention and most likely to be cited by the Patent Office examiners against it. Frequently he can so draw his application as to anticipate these probable adverse citations or avoid them. Still another advantage is that the advance search may suggest to the attorney or the inventor applications or modifications of the invention which have not been thought of, thus broadening or strengthening the application as filed.

Rejection of applications by the Patent Office is usually by individual, numbered claims. Some claims of an application may be rejected and others allowed, or all may be rejected or all allowed. Following notice of rejection, the inventor has six months to reply, either with argument or by amendment of the rejected claims, to meet the objections of the Office.

Inventors who wish to keep cases in the Patent Office as long as possible, either to complete their research work or to delay



# JUST THE THING FOR SERVICEMEN WHO ARE "FROM MISSOURI"

Maybe you think that radio schools and courses are not for you. Perhaps you think they're ALL for beginners—that they can't be of any real help to a man already in the service game.

If so, you're just the fellow I want to talk to. For when I say that Sprayberry's Practical Mechanics of Radio Service is different, I mean DIFFERENT.

It contains no "fluff", fancy bindings, high pressure selling or a raft of theory with which you're already familiar. But it does contain plenty of sound, practical help on every phase of service work—just the kind of up-to-the-minute advanced training every serviceman needs and at a price he can afford to pay.

But I won't describe it here. As one man from Missouri to another, I only ask you to give me a chance to SHOW YOU. Just send the coupon today. It will cost you nothing to investigate. If I don't "show you", you don't spend even the small cost asked for Sprayberry training. And even if you do buy you must be satisfied or every cent will be refunded in strict accordance with my Money-Back guarantee. Nothing could be fairer!

It's your move next!  
**This coupon will help you save \$3**

**F. L. SPRAYBERRY** 2548 University Pl., N.W. Washington, D. C.

Sure! Tell me all about SPRAYBERRY'S Practical Mechanics of Radio Service. Also give details of your offer whereby I can get the new series of Sprayberry Data Sheets (worth \$3) at no additional cost. It is understood this request entails no obligation on my part.

Name.....  
Complete Address.....  
RN1-35

**SPRAYBERRY'S PRACTICAL MECHANICS OF RADIO SERVICE**



**free!**

**100% SHORT-WAVES**  
52 Pages—50 Hookups  
ALL ABOUT: Xmitting and Receiving Antennas, Bandspreading, Receiving Foreign Stations, Xmitting tubes. HOW TO BUILD "19" Twinplex, 5 and 10 Meter Xmitter, "203-A" Xmitter, Bandspread Dierle Set. How To Get Started in Short Waves, etc., etc. Send in U. S. coin or stamps for postage. Treatise sent by return mail.

**RADIO TRADING CO.** 95 Hudson St. New York City

# CHOICE OF AN EXPERT

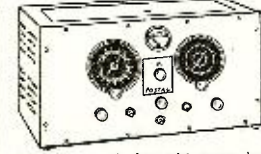

The NEW POSTAL CUSTOM BUILT '35 ALL-WAVE RECEIVER was chosen by a famous Short Wave Authority as the official receiver for his DX Listening Post.  
The Postal '35 is custom built for the better Short Wave Fan, Amateur and Commercial operator. Emphasizes over 50 new features.

Sold with a 10 day trial money back guarantee. WRITE IMMEDIATELY FOR FREE CIRCULAR NO. 150 WHICH COMPLETELY DESCRIBES THE POSTAL SET CHOSEN BY THE FAMOUS S. W. EXPERT

**POSTAL RADIO**  
135-J LIBERTY ST. NEW YORK, N.Y.



**SO SMALL YET  
SO POWERFUL**

A 10-watt . . . yet no larger than usual 1-watt carbon job! Aerovox Pyrohm Junior resistors are genuine wire-wound, vitreous-enamelled resistors designed to meet the demand for small size, low price, high-resistance and high-wattage rating. Note these features:

- Quality resistance wire wound on porcelain tube.
- Wire ends brazed to lugs . . . pigtail leads soldered to terminal leads.
- Entire unit coated with vitreous enamel for moisture and mechanical protection.
- In 5, 10, 15 and 20 watt ratings . . . wide range of resistance values.

Aerovox resistors are fit companions for Aerovox condensers . . . truly reliable components for assemblies that must prove reliable.

**DATA FREE** . . . new 1935 Aerovox catalog describes complete line. Also monthly Research Worker covering applications . . . sample copy on request.



**CORPORATION**

78 Washington Street  
Brooklyn, N. Y.



**WATCH THE "LEADERS"  
FOLLOW LYNCH**

For more than two years Arthur H. Lynch has been emphasizing the fact that

**"No Radio Can Be Better Than Its Aerial"**



TRADE MARK REGISTERED  
(High-Fidelity)

**ANTENNA SYSTEMS**

are as superior to all other antenna systems as the present high-fidelity radio receivers are superior to the noisy, squealing sets of years ago. The "leaders" are just beginning to realize they have been playing a game of Rip Van Winkle.

**ASK YOUR DEALER**

to demonstrate a LYNCH Antenna— or write us for free literature.

**Then COMPARE!**

**ARTHUR H. LYNCH, INC.**  
227 Fulton St., New York, N. Y.  
PIONEER OF NOISE-REDUCING AERIALS

**STEP AHEAD**

IN THE SERVICE PROFESSION WITH CASE RECORDS OF BROADCAST RECEIVER REPAIRS

ADD 10,000 HOURS to your experience! ELIMINATE GUESS-WORK in your Servicing.

**DON'T PUZZLE YOUR PROFITS AWAY!**

Your work is already done and recorded for you in "CASE RECORDS". This 9x12" leatherette binder CONTAINS 1,500 alphabetically and numerically arranged case records of SUCCESSFULLY COMPLETED SERVICE JOBS. Each Record tells—symptom—causes responsible—electrical values—location—and best replacement or repair. Fastest Servicing technique known. 108 Receiver Makes—3,000 Models. SUPPLEMENTED QUARTERLY FREE for 1 year. Free Consultation Service.

\$4.75 Postpaid.

**CAPITOL RADIO RESEARCH LABORATORIES INC.**  
1503-21st. St. N. W., Wash., D. C.

Kindly forward full details on "CASE RECORDS".

NAME.....  
ADDRESS.....

the beginning of the 17-year period during which the patent will be in effect, often take full advantage of the opportunity for amendment and of each six-months period allowed for the inventor's reply. While this is not, strictly speaking, in accordance with either the desires or the regulations of the Patent Office, I never have heard of any inventor being penalized for doing it.

Even after final rejection of a claim or an application by the Patent Office examiner, the inventor may appeal from this decision to the Board of Appeals in the Patent Office, next to the United States Court of Customs and Patents Appeals and ultimately, in suitable cases, to the Supreme Court of the United States.

Members of Congress or other governmental officials, even the highest, have little influence over the progress of a patent through the Patent Office. I have known of a few instances in which high governmental authority did succeed in having cases held up or advanced in Office consideration but never even one case where there was suspicion of political or similar influence over the Patent Office's decision. The eager inventor unable to bring the Patent Office to his point of view will get nowhere by writing to his Congressman and might better save his postage and the Congressman's time.

When at least one of the claims of a patent has been allowed by the Patent Office and the inventor has consented, actively or tacitly, to the rejection of any other claims, the official patent is issued and delivered to the inventor. Copies of the patent then are printed and may be purchased by anyone from the Patent Office at a price of ten cents each. A brief abstract of the patent or claims is printed in the official Patent Office Gazette, a weekly magazine issued by the Superintendent of Documents, Washington, D. C., at a subscription price of \$16.00 a year.

The official fee charged by the Patent Office for filing each application for a patent is \$30. \$1.00 extra is charged for each claim in excess of 20. If the patent is allowed, an additional fee of \$30 is required before it is issued, again with the increase of \$1.00 for each claim in excess of 20. Other fixed fees are required for appeals,

**STATEMENT OF THE OWNERSHIP, MANAGEMENT, CIRCULATION, ETC., REQUIRED BY THE ACT OF CONGRESS OF MARCH 3, 1933.**

Of RADIO NEWS AND THE SHORT WAVE, published monthly at Dunellen, N. J., for October 1, 1934.

State of New York } ss.  
County of New York }

Before me, a Notary Public in and for the State and county aforesaid, personally appeared Lee Ellmaker, who, having been duly sworn according to law, deposes and says that he is the Business Manager of the RADIO NEWS AND THE SHORT WAVE and that the following is, to the best of his knowledge and belief, a true statement of the ownership, management (and if a daily paper, the circulation), etc., of the aforesaid publication for the date shown in the above caption, required by the Act of March 3, 1933, embodied in section 537, Postal Laws and Regulations, printed on the reverse of this form, to wit:

1. That the names and addresses of the publisher, editor, managing editor, and business manager are: Publisher, Teck Publications, Inc., 461 Eighth Ave., New York, N. Y.; Editor, L. M. Cockaday, 461 Eighth Ave., New York, N. Y.; Managing Editor, None; Business Manager, Lee Ellmaker, 461 Eighth Ave., New York, N. Y.

2. That the owner is: (If owned by a corporation, its name and address must be stated and also immediately thereunder the names and addresses of stockholders owning or holding one per cent. or more of total amount of stock. If not owned by a corporation, the names and addresses of the individual owners must be given. If owned by a firm, company, or other unincorporated concern, its name and address, as well as those of each individual member, must be given.) Teck Publications, Inc., 461 Eighth Ave., New York, N. Y.; Lee Ellmaker, 461 Eighth Ave., New York, N. Y.

3. That the known bondholders, mortgagees, and other security holders owning or holding 1 per cent. or more of total amount of bonds, mortgages, or other securities are: (If there are none, so state.) None.

4. That the two paragraphs next above, giving the names of the owners, stockholders, and security holders, if any, contain not only the list of stockholders and security holders as they appear upon the books of the company, but also, in cases where the stockholders or security holder appears upon the books of the company as trustee or in any other fiduciary relation, the name of the person or corporation for whom such trustee is acting, is given; also that the said two paragraphs contain statements embracing affiant's full knowledge and belief as to the circumstances and conditions under which stockholders and security holders who do not appear upon the books of the company as trustees, hold stock and securities in a capacity other than that of a bona fide owner; and this affiant has no reason to believe that any other person, association, or corporation has any interest direct or indirect in the said stock, bonds, or other securities than as so stated by him.

LEE ELLMAKER, Publisher.

Sworn to and subscribed before me this 1st day of October, 1934.

CHARLES F. BRAND, Notary Public.  
Westchester County.

N. Y. County Clerk's No. 675.  
New York Register's No. 5-B-405.  
My Comm. expires Mar. 30, 1935.

**INDEX OF ADVERTISERS**

Aerovox Corp. . . . .	454	McGraw-Hill Book Co., Inc. . . . .	448
Alden Products Co. . . . .	434	Massachusetts Radio & Telegraph School . . .	434
Allied Radio Corp. . . . .	397	Midwest Radio Corp. . . . .	Fourth Cover
American Transformer Co. . . . .	440	National Company, Inc. . . . .	Third Cover
Amperite Corp. . . . .	448	National Radio & Electrical School . . . . .	453
Amplivox Laboratories . . . . .	453	National Radio Inst. . . . .	393
Automatic Electrical Devices Co., The . . . . .	451	National Union Radio Corp. . . . .	439
Baltimore Radio Corp. . . . .	439	New York Y.M.C.A. Schools . . . . .	455
Birnbach Radio Co., Inc. . . . .	456	Postal Radio Corp. . . . .	453
Bruno Laboratories . . . . .	434	RCA Institutes, Inc. . . . .	451
Bud Speaker Co. . . . .	442	RCA Radiotron, Inc. . . . .	433
Burnstein-Applebee Co. . . . .	456	RCA Victor Co., Inc. . . . .	415
Candler System Co., The . . . . .	455	Radio Circular Co., Inc. . . . .	452
Capitol Radio Engineering Inst. . . . .	440	Radio & Technical Publishing Co. . . . .	442, 456
Capitol Radio Research Laboratories, Inc. . . . .	454	Radio City Products Co. . . . .	455
Central Radio Laboratories . . . . .	447	Radio Trading Co. . . . .	453
Chicago Radio Apparatus Co. . . . .	452	Radio Training Association of America . . . . .	444
Classified Advertisements . . . . .	452	Ranken, Jr., School of Mechanical Trades, The David . . . . .	452
Coast-to-Coast Radio Corp. . . . .	444	Readrite Meter Works . . . . .	445
Cornish Wire Co., Inc. . . . .	446	Rider, John F. . . . .	436
Corona Hotel . . . . .	453	Rivard Mfg. Co. . . . .	448
Coyne Electrical School . . . . .	438	Scott Radio Labs., Inc., E. H. . . . .	411
Dodges Institute . . . . .	439	Shallcross Mfg. Co. . . . .	436
Electrad, Inc. . . . .	437	Silver, Inc., McMurdo . . . . .	395
Experimental Radio Labs. . . . .	456	Solar Mfg. Corp. . . . .	453
General Electric Co. . . . .	Second Cover	Spraberry, F. L. . . . .	453
Hallcrafters Inc. . . . .	452	Supreme Instruments Corp. . . . .	431
Hammarlund Mfg. Co. . . . .	443	Teleplex Co. . . . .	453
Hetro Electrical Industries . . . . .	446	Trimmo Radio Mfg. Co. . . . .	456
Hull Mfg. Co. . . . .	452	Triplet Electrical Instrument Co. . . . .	435
Hygrade-Sylvania Corp. . . . .	441	Tri-State College . . . . .	453
Instructograph Co. . . . .	456	Try-Mo Radio Co., Inc. . . . .	455
Instruct Corp. of America . . . . .	455	Van Leuven, L. L. . . . .	448
International Correspondence Schools . . . . .	456	Webster Co., The . . . . .	439
Kato Engineering Co. . . . .	451	Weston Electrical Instruments Corp. . . . .	449
Kenyon Transformer Co., Inc. . . . .	438	Wholesale Radio Service Co. . . . .	451
Lynch, Inc., Arthur H. . . . .	454	Yaxley Mfg. Co., Inc. . . . .	398



### RADIO OPERATING RADIO SERVICING



Prepare for the new Government Radio Operating license examinations; Radio Operator, Marine and Broadcasting. Also Radio Amateur Telegraph and Telephone. Resident courses.

*Write for  
Booklet*

**New York YMCA Schools**  
7 West 63rd Street New York City

## NEW

### RADIO CATALOG

Just off the Press! Hundreds of latest developments in Short Wave and 5-Meter parts and accessories. Everything for the Serviceman, Ham, Amateur and Experimenter! Sensational new line of S.W. Receiver Kits from 1 to 5 tubes. RCA-Hazeltine license. Send 10c coin or stamps to partially defray cost of handling and mailing. Get your copy at once.

**INSULINE CORP. OF AMERICA**  
23-25 Park Place Dept. R-15. New York, N.Y.

### You Can Become a Fast, Capable RADIO OPERATOR at Home

The **CANDLER SYSTEM** Makes it easy for you! If you want to learn code QUICK ask about *Junior Course* for beginners. If you lack speed ask about *Advanced Course—HIGH SPEED TELEGRAPHING*. Whether Beginner, Amateur or Com'l op., tell us what ticket you're going up for and we'll show you how EASY it is to get.

**CANDLER SYSTEM** gives you Speed, Accuracy and ability to Copy Behind—shows you how to use "mill" in copying fast stuff. All questions answered. Save time and money by sending for FREE BOOK today!



**CANDLER SYSTEM CO., Dept. M-1**  
6343 So. Kedzie Ave., Chicago, Ill.

## FREE!

### "23 Lessons In Radio" With 5 Issues of RADIO NEWS at \$1

We still have a very limited supply of the famous book "23 Lessons In Radio" on hand. No further reprints will be made. If you want a copy, we advise you to send for it immediately!

"23 Lessons In Radio" covers the fundamentals including elementary radio theory, radio tubes, principles and construction of receivers, converters and transmitters, standard radio symbols, the amateur field, and many other important items.

Get your copy now—it's FREE with 5 issues of RADIO NEWS at \$1.

## RADIO NEWS

---

Radio News, Dept. 351A  
461 Eighth Ave., New York, N. Y.

Enclosed find \$1 for which kindly send me the next 5 issues of RADIO NEWS and my free copy of "23 Lessons In Radio." (Canada \$1.25—Foreign \$1.50.)

Name .....

Address .....

City .....

State .....

revival of abandoned applications and some other services of the Office. These are the governmental fees, not including the charges of a patent attorney. Such attorney's charges may run from less than \$50.00 to many thousands of dollars, depending upon the experience and standing of the attorney and the amount of work which has to be done.

I have met inventors who fear that during this long and sometimes slow procedure in the Patent Office, some agent of a "big corporation" or other representative of predatory wealth will get private information from the Patent Office and will steal their inventions. It is true that some large industrial organizations and others do maintain employees in Washington to watch issued patents and other developments in the Patent Office. I suspect that some of these agents, if they are adroit and well connected, might obtain advance information at times concerning pending patent applications or other matters not yet decided by the Patent Office. Perfect secrecy and human nature are unlikely to go together and neither the Patent Office nor its employees are super-human. However, the degree of secrecy actually maintained by the Patent Office impresses me as remarkable, and anyway, it doesn't matter.

Even if someone does learn of your patent before it finally is issued or is rejected, that person can do nothing except contrive what is called an interference or else file an application of his own covering some phase of your idea which you should have included in your application but forgot. If you forget anything it is your own fault and an interference will be decided, unless you have been careless, in accordance with justice and with the facts.

An interference means that the Patent Office discovers among its other pending applications one which seems to cover the same invention embodied in your application or a very similar one. When this happens, legitimately or otherwise, the procedure, before either patent is issued, is to inquire who made the invention first. This is one reason why inventors should keep careful, dated notes of everything they do. Why and how to do this is, however, a subject in itself, which I shall reserve for the next article of this series; together with the still more important matter of how to select a patent attorney when you need one.

## A New Power Pack

(Continued from page 403)

isolated, electrically, from all other circuits. When using the power pack with receivers which have heretofore been battery-operated, the filament wiring should be checked over carefully to make sure that it connects to no other circuits. Also, if it doesn't already consist of a twisted pair, the circuit should be rewired in this manner. If this precaution is followed, humless operation will be obtained even though the receiver include a regenerative circuit.

The details of construction are clearly shown in Figures 1 and 2. In Figure 2, the front and rear sides of the chassis are shown in a flattened out position to clarify the wiring. All leads from the power transformer are brought down through the two holes marked T, Figure 2. These leads are color-coded as shown.

### Parts List

- C1, C2—Aerovox 2-section electrolytic condenser, type GG, 8-8 mfd, 450 v.
- C3, C4, C5—Aerovox 3-section electrolytic condenser, type GGG, 4-4-4 mfd, 450 v.
- C6—Aerovox mica condenser, .006 mfd.

## 192 PAGES

### SHORT WAVE PUBLIC ADDRESS MANUAL

50¢

One of the most complete informative radio books ever published to sell for such a low price. Every radio man—from the novice to the finished operator—will find this manual an indispensable asset to his library.

Subjects of interest today—**SHORT-WAVES, TRANSMITTING, PUBLIC ADDRESS and TESTING DEVICES** are all dealt with in intricate care. Complete information is given, dwelling on construction, function and operation.

Over 100 illustrations including schematic and pictorial diagrams for construction. An illustration is shown of every unit portraying the finished appearance.

Valuable articles by many famous radio engineers and short-wave experts. Every type of receiver is described from a one tube battery set to the modern ALL-WAVE Receiver.

The manual fully describes the **POWER-TONE 6 TUBE SUPER** advertised below, with diagrams and list of every part.

### ★ The ALL-STAR All-Wave Superheterodyne ★

is described in every detail in the manual.  
**GET YOUR COPY TODAY!**

*If you are not satisfied with the manual, return it immediately and we will refund your money.*

## POWER-TONE 6 Tube Superheterodyne ALL-WAVE RECEIVER



DESCRIBED in Radio News Nov., 1934. Latest tubes—1-2A7, 2-58's, 1-55, 1-2A5 and 1-8'90 rectifier. A. V. C., single dial; low noise level; no background noise; complete tuning of all bands.

Complete Kit with 8 Bruno Coils and dynamic speaker..... **\$24.50**

With Airplane dial, extra..... **\$1.50**

Wired and tested, extra..... **5.00**

Kit of RCA licensed tubes..... **4.95**

Set of 2 broadcast coils (200-550)..... **1.50**

**TRY-MO RADIO COMPANY, Inc.**  
85-R Cortlandt St., New York City  
Send For New 1935 Catalog

### New, Better, Lower-Priced ANALYZER UNIT



Connect the new "DEPENDABLE" Model 501 ANALYZER UNIT to the meter of your obsolete analyzer—or better still, to the new "DEPENDABLE" 403-A MULTITESTER, and have a modern and efficient analyzer without expensive investment. Model 501 is the only analyzer combining all of its desirable features. Will not get out-of-date.

COMPLETE, ready to operate, **\$10.95.**  
KIT, **\$9.25.**

"DEPENDABLE" Shunts guaranteed accurate within 1%, \$4c each. 2% accuracy, 75c.

MULTIPLIERS

guaranteed noise less and accurate within 1% or 2%, 5,000 to 10-million ohms, 49c to \$2.55 each. Special values to order.



Write for FREE Data Sheets

### RADIO CITY PRODUCTS CO.

Dept. RN-1, 48 W. Broadway, New York

### SERVICEMEN

Your Hard of Hearing installations will be judged by the earphones you use. A satisfied customer is your best salesman—satisfaction is assured when you use

#### TRIMM FEATHERWEIGHT EARPHONES



Highest in Quality. Unsurpassed in comfort.

**TRIMM RADIO MFG. CO.**  
The Pacemakers in Earphone Development.  
1528 Armitage Ave. Chicago, Ill.

## AIR CONDITIONING

### THE NEXT BIG INDUSTRY

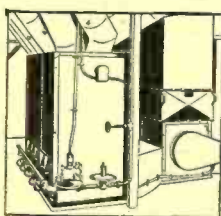

Plumbing and heating engineers must know Air Conditioning—the field in its broader aspects invites ambitious men. Write for information on the new Air Conditioning Course offered by the International Correspondence Schools.

### ... INVENTION—a field of opportunity for men with ideas

If you have an inventive turn of mind, this new course in inventing and patenting will teach you all the basic knowledge you need to earn real money from your talents. The coupon will bring full information—FREE!



### AVIATION ENGINEERS are leaders in modern progress



Expert knowledge of aviation engines is a long step toward success in this rapidly growing industry. Many aviation engineers today took their first step by mailing a coupon to I. C. S. at Scranton. Why don't you?

### RADIO holds great rewards for trained men

Almost in a decade radio has become a giant industry. The opportunities created will be enjoyed by trained men. The I. C. S. Radio Course, prepared by leading authorities, will help make you a trained man! A fascinating book—FREE.



**INTERNATIONAL CORRESPONDENCE SCHOOLS**  
BOX 8281-P, SCRANTON, PENNA.

Without obligation, send me full information on subject checked below:

Air Conditioning  
 Inventing and Patenting  
 Aviation Engines

Radio

<input type="checkbox"/> Architecture	<input type="checkbox"/> Highway Engineering
<input type="checkbox"/> Concrete Construction	<input type="checkbox"/> Poultry Farming
<input type="checkbox"/> Mechanical Engineering	<input type="checkbox"/> Drafting
<input type="checkbox"/> Reading Shop Blueprints	<input type="checkbox"/> Accounting
<input type="checkbox"/> Civil Engineering	<input type="checkbox"/> Good English
<input type="checkbox"/> Electrical Engineering	<input type="checkbox"/> Salesmanship
<input type="checkbox"/> Diesel Engines	<input type="checkbox"/> Advertising
<input type="checkbox"/> Gas Engine Operating	<input type="checkbox"/> Show Card Lettering
<input type="checkbox"/> Refrigeration	<input type="checkbox"/> Civil Service
<input type="checkbox"/> Chemistry	<input type="checkbox"/> High School Subjects

Name \_\_\_\_\_  
Address \_\_\_\_\_

- CH1, CH2—Thordarson chokes, type T-4402
- RFC—Hammarlund r.f. choke, type CH-X
- R1—Electrad center-tapped filament resistor, 30 ohms
- R2—Electrad, type C-200, Truvolt voltage divider, 20,000 ohms, 50 watts; with 3 adjustable intermediate taps
- SW—Toggle switch, s.p.s.t.
- T—Thordarson power transformer, type T-5472; secondaries 340-0-340 volts (55 ma.), 5v (2 amps.), 6.3 v. (1.5 amps.)
- 1—Eby 4-prong socket, type 12
- 1—Eby 6-prong socket, type 12
- 1—Eby 6-prong cable plug, male
- 1—6-conductor cable
- 1—Line cord and plug
- 1—"Blan the Radio Man" drilled chassis, type RN-12. 8½ inches long, 4½ inches wide and 2¼ inches high
- 1—Rubber grommet (½ inch) for power cord hole in chassis

## Identifying Stations

(Continued from page 399)

data on the few short-wave stations transmitting throughout the world at that time. During the growth of our means of gathering information, we found that there were a few (44 in number) stations that could be relied upon to present regular programs on the short waves.

In April, 1933, these were included in a listing in RADIO NEWS, under the title "Short-Wave Best Bets." The wavelength, call letters and station locations were included. A log was kept with a short-wave set in the Editor's home at Pelham in order to make up the list each month. The Editor has added the most modern types of receivers to this post which has become known as the Westchester Listening Post. In this way the list grew and has continued to grow as more stations were erected in more countries throughout the world. Later it was decided to make the list international in scope, listing all stations that could be heard anywhere. This called for additional Listening Posts situated in strategic spots around the world. Thus was born the now famous association of pioneer short-wave listeners, known as the RADIO NEWS Short-Wave Listening Post Observers. They are promoting short-wave radio by logging diligently and accurately the times when stations are on the air and giving due notice to our editors when new stations are being built and new transmission inaugurated. Our own postal and cable service to and from these stations is used to recheck the programs and from these three sources the present time schedules are evolved.

All a listener has to do is to consult his watch for the time and then find that time in our World Short-Wave Time-Table, published and revised each month in the DX Corner for Short Waves, and he will find what stations are on the air and their wavelength, frequency and location will become immediately evident as they tune them in. We know of no better way for identifying short-wave stations than that presented in the DX Corner for Short Waves, in RADIO NEWS—do you?

## Inductor Microphone

(Continued from page 421)

trol frequency response to maintain a fairly uniform overall characteristic.

A built-in transformer has a tapped secondary to feed either a 25-ohm or 250-ohm line.

## Trouble-Shooting Gadget



# 25c

Servicemen say this is the handiest little gadget they ever saw. For all major receiver symptoms it gives you all possible trouble sources (275 in all!). Keep one in your pocket—it will save you "headaches" and wasted time. Get yours today—

**RADIO & TECHNICAL PUBLISHING CO.**  
45 Astor Place, New York. Dept. RN-1

Designed by A. A. Ghirardi and B. M. Freed, Authors of "MODERN RADIO SERVICING", soon to be published.

## BIRNBACH All-Wave ANTENNA



NEW-type insulators and transmission line make this one of the most efficient all-wave antenna systems ever devised. Complete kit—nothing else to buy. Easily, quickly erected. Only \$3.75 list.

Birnbach makes also the most complete line of high-grade navy-type Insulators, Aerial Wire, Hook-up Wire, Antenna Kits, etc.

Write Dept. RN-1 for FREE Data Sheets.

**BIRNBACH RADIO CO., Inc.**  
145 Hudson Street New York City

## RADIO CODE

Learn at Home  
It's EASY With  
Instructograph



Ask any Radio Operator . . . Provides regular, systematic CODE PRACTICE day or night, obtainable in no other way . . . No experience necessary . . . Complete outfit—Instructograph Automatic Code Teaching Machine, graduated lesson tapes, head phones, key and Complete Course of Instruction for sale or rent . . . Terms as low as \$2 per month . . . Rent for a month . . . Be convinced Instructograph has no equal. If not, send it back . . . Make more progress in two months with Instructograph, than in six months in school! . . . writes one code student . . . Send postcard for details . . . No obligation.

**INSTRUCTOGRAPH COMPANY**  
912 Lakeside Pl., Dept. NR-13, Chicago, Ill.

## World famous INTERNATIONAL DX

3 Tube Short-Wave Receiver  
ALL ELECTRIC  
ALL WAVE

EXCELS in performance, selectivity, sensitivity and volume.  
FREE circular up to 5 tube SHORT WAVE RECEIVERS.

# 6.75

COMPLETE Kit with Speaker, 4 Coils to cover 14 to 200 meters and plain diagrams

EXTRA for WIRING 1.75  
Set of 3 matched ARC-TURUS tubes . . . \$2.25  
Broadcast coil 200-500 meters . . . .75  
METAL CABINET as illustrated above . . . 1.95

**EXPERIMENTAL RADIO LABS.**  
168 N. Washington St. New York, N. Y.

When It's Needed in a Hurry!  
Servicemen — Amateurs — Experimenters  
Depend on  
**BURSTEIN-APPLEBEE CO.**

America's Livest Radio House in America's Handiest Shipping Point.

1012-A McGee St. Dept. 151 Kansas City, Mo.

# 1935 Catalog

148 Pages  
Write us if you haven't a copy.

# Have You Received Your Copy

OF THE NEW NATIONAL CO. CATALOGUE?

*If Not, Don't Delay*

**NEW RECEIVERS!**

**NEW PARTS!**

Ask Your NATIONAL Dealer or Use Coupon Below

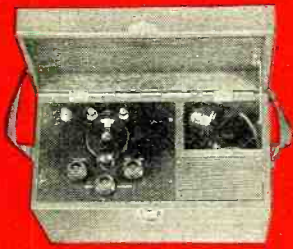
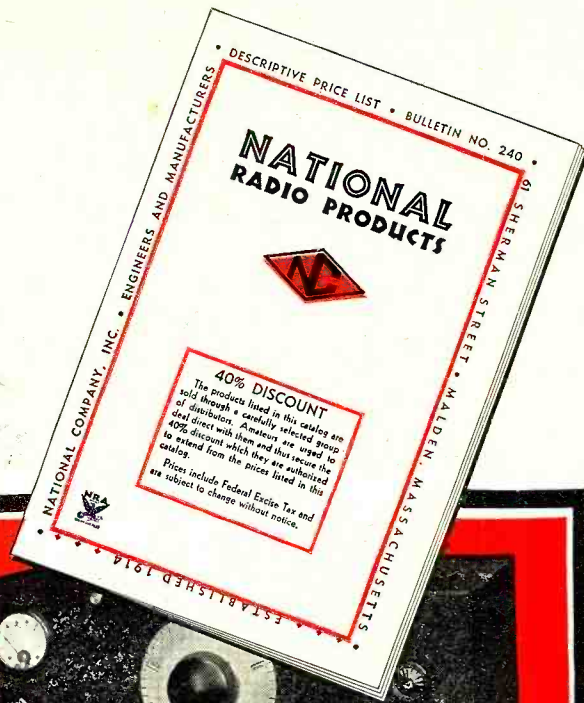

**NEW TR 56 MC TRANSCEIVER**  
A portable combination 5 meter receiver and transmitter (special booklet available). Uses two tubes.



**New Cathode Ray Oscilloscope**  
Provides instantaneous graphic picture of actual operating conditions in transmitter circuits. (Booklet available).



**NEW TYPE HRO AMATEUR RECEIVER**  
Two stages of pre-selection, two air-tuned IF stages, calibrated band spread, automatic volume control, 4-gang condenser, micrometer dial, single signal filter, new ganged plug-in coils, vacuum tube voltmeter, and many other new features.



**New TMS Transmitting Condenser**  
For low power use. Steatite-isolatite insulation. Compact, inexpensive.



**New TMC Transmitting Condenser**  
For power stages where peak voltages do not exceed 3000. Compact, rigid.



**New NC 800 Neutralizing Condenser**  
For high voltage use, especially with RCA-800.



**New M30 Mica Padding Condenser**  
Steatite mounting. Max. capacity 30 mmf.



**New Type XR-9 Five-Meter Coil**  
Copper coil, air-spaced winding on Steatite base.

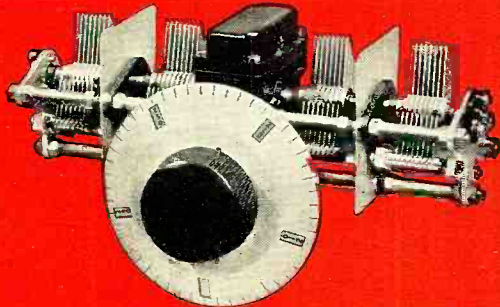

**NEW PW PRECISION CONDENSER & MICROMETER DIAL UNIT**  
A new and entirely self-contained ganged condenser unit for high frequency receivers. Worm-gear drive 20:1 ratio. Full of new and advanced features.



**New Type CH Crystal Holder**  
Holds crystal vertically. 2 forms, for transmitting or for resonator use.



**New XT-8 Choke Coil Form**  
Steatite form for small choke coils and resistances



**New TX-9 Shaft Coupling**  
Steatite insulation, for isolating circuits.

Illustrated above are just a few of the many new items shown in the new National Catalogue No. 240. National Radio Products include these and many other new items, and of course the well-known National Velvet Vernier Dials, Transmitting Condensers, Receiving Condensers, IF Transformers, RF Chokes, Sockets, Coil Forms, Coil Shields, Transformers, and HF Dielectrics.

Included also are the famous NATIONAL AGS and AGSX Receivers, the FB-7A and FB-XA Amateur Receivers, the SW-3 High Frequency Receiver, the PSK Preselector, the SRR 5 Meter Super-Regenerator Receiver, the HFC 5 Meter Converter—as well as the power units for operating these receivers. Call at your National Dealer's today for a free copy of this new catalogue, or send coupon below, enclosing 6c to cover mailing costs.

**NATIONAL COMPANY, INC., 61 SHERMAN STREET, MALDEN, MASS.**



Gentlemen: Please send me your new catalogue No. 240. I enclose 6c to cover mailing costs.

Name..... Address..... RN-1-35

SAVE UP TO 50% by BUYING YOUR RADIO *Direct from* MIDWEST LABORATORIES

Thrill to *Guaranteed World-Wide* HIGH FIDELITY Performance with This Amazing New 1935 MIDWEST SUPER Deluxe 16-TUBE ALL-WAVE Radio! (ALL FIVE WAVE BANDS)

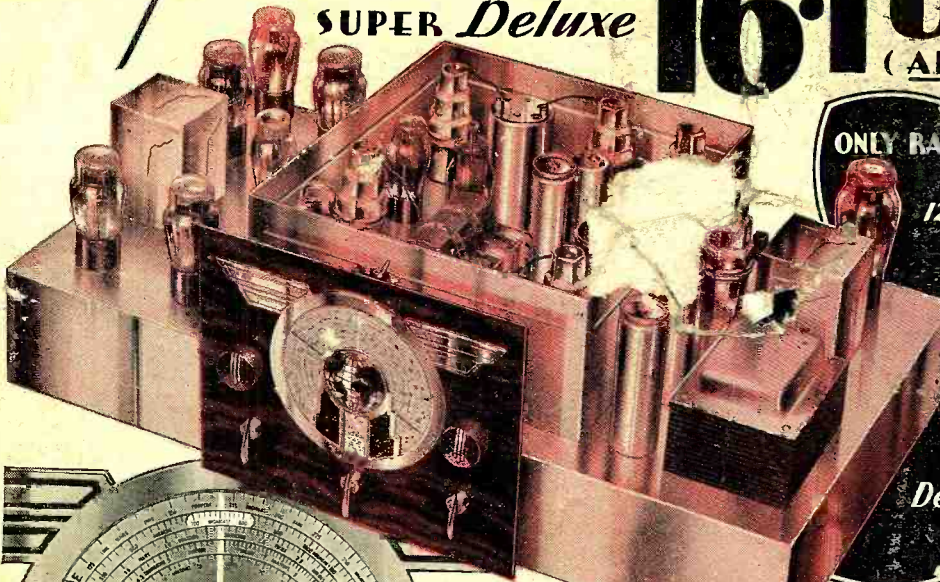

ONLY RADIO COVERING  
9 TO 2,400 METERS.  
12,000 MILE TUNING RANGE  
WORLD'S GREATEST  
RADIO VALUE  
**\$57<sup>50</sup>** with New  
Deluxe Auditorium-Type  
SPEAKER  
(LESS TUBES)

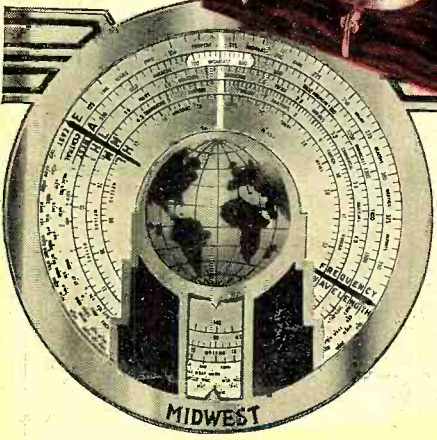

30 Days FREE Trial!

TERMS  
as low as  
**\$5<sup>00</sup>**  
DOWN

BEFORE you buy any radio write for the new FREE 1935 Midwest "Fifteenth Anniversary" catalog and see for yourself the many reasons why 110,000 satisfied customers bought their radios direct from the Midwest Laboratories and saved from 1/3 to 1/2. Why pay more than the direct-to-you laboratory price? You, too, can make a positive saving of from 30% to 50% by buying this more economical way. Learn why Midwest outperforms sets costing up to \$200.00 and more. Never before so much radio for so little money! Midwest gives you triple protection with: **One-Year Guarantee, Foreign Reception Guarantee, Money-Back Guarantee.**

**Only Midwest Gives You Multi-Function Dial**  
This dial was designed in keeping with the trend of the times, yet is not an airplane dial! It is a many-purpose dial that performs many functions. Now, Midwest guarantees that inexperienced persons can secure good foreign reception. Send for FREE miniature of actual rotating dial which clearly shows these outstanding advantages:  
1. Dial calibrated in Kilocycles, Megacycles and Meters;  
2. Call letters of American Broadcast Stations printed on dial and illuminated;  
3. Slow-Fast, Smooth-Acting Tuning;  
4. Station Group Locator;  
5. Simplified Tuning Guide Lights;  
6. Automatic Select-O-Band Indicator;  
7. Illuminated Pointer Indicator;  
8. Silent Shadow Tuning—Improvement on Meter Tuning;  
9. Centralized Tuning.

**50 ADVANCED 1935 FEATURES**  
Many exclusive features include: Micro-Tenuator... Fidel-A-Stat... Separate Audio Generator... Ceramic Coil Forms, etc. Only Midwest covers a tuning range of 9 to 2400 meters (33 Megacycles to 125 KC)—enabling you to easily and successfully tune in even low-powered foreign stations up to 12,000 miles away with crystal-clear, loud-speaker reception.  
All 5 Wave Bands enable you to enjoy today's finest High Fidelity American programs. In addition, you get Canadian, police, amateur, commercial, airplane and ship broadcasts and derive new delight and new excitement from un-

equalled world-wide broadcasts... England, France, Germany, Spain, Italy, Russia, Australia, etc. Send today for money-saving facts!  
**SENSATIONAL, HIGH FIDELITY RECEPTION**  
This bigger, better, more powerful, clear-toned, super selective, 16-tube radio gives you absolute realism—assures you of life-like, crystal-clear tone—unlike anything you have ever experienced before. You will hear one more octave—overtone—that cannot be brought in with ordinary radios. Now, hear every instrument, every voice, every shade and inflection of speech.  
Take advantage of the amazing 30-day FREE trial offer. Send for FREE catalog.

**Listens to World-Wide Reception**  
Middle-town, O.—Here are some of the stations I have heard: EAQ, Madrid, Spain—DJB, Zeelen, Germany—GSB, GSF, Daventry, England—VKME, Melbourne, Australia—VK2ME, Sydney, Australia—HJ2ABA, HJ4ABE, HJ3ABF, Colombia, S. A., and many more. Golden Hatfield, 2206 Grand Avenue.  
**Peruvian Praises Foreign Reception**  
Lima, Peru—We have heard the five continents with your Midwest. Have received Madagascar, Sydney, London, Paris, Vienna, Moscow, Madrid, New York, Shanghai, Tokio and also South American transmitters. Marquis H. Buchanan, Apartado 96, Plaza San Martin, 171.

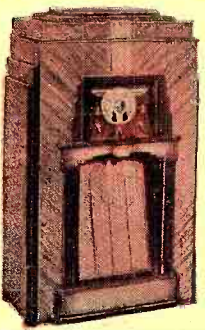

**New Style Consoles**  
The Midwest 36-page catalog pictures a complete line of beautiful, artistic de luxe console and chassis in four colors. Write for new FREE catalog today!  
Midwest long-range radios are priced as **\$27<sup>50</sup>** low as...

**DEAL DIRECT WITH LABORATORIES**  
Increasing costs are sure to result in higher radio prices soon. Buy before the big advance... NOW... while you can take advantage of Midwest's sensational values... no middlemen's profits to pay. You can order your 1935 High Fidelity radio from the new Midwest catalog with as much certainty of satisfaction as if you were to select it in our great radio laboratories. You save 30% to 50% when you buy this popular way... you get 30 days FREE... as little as \$5.00 down puts a Midwest radio in your home. Satisfaction guaranteed... money-back. Write for new FREE catalog today.

**MAIL COUPON TODAY! FOR AMAZING 30-DAY FREE TRIAL OFFER AND NEW 1935 CATALOG**

MIDWEST RADIO CORP., Dept. 833 Cincinnati, Ohio.  
Without obligation on my part send me your new FREE 1935 catalog, FREE Miniature Dial, and complete details of your liberal 30-day FREE trial offer. This is NOT an order.

Name.....  
Address.....  
Town..... State.....

User-Agents Make Easy Extra Money  
Check Here for Details

**MIDWEST RADIO CORP.**  
DEPT. 833 — CINCINNATI, OHIO, U. S. A.  
Established 1920 Cable Address Miraco. . . . All Codes